





<b>Product Series :</b> GSTV	<b>Brand :</b> GOTREND
<b>File Version :</b> GSTV-SERIES-AG-V1R0	<b>Editor :</b> Qiuyi Wu
<b>Established Date :</b> 2023.03.24	<b>Description :</b> High Current Inductor
<b>Latest Edit Date :</b> 2023.03.24	<b>Product Type :</b> <input checked="" type="checkbox"/> Standard <input type="checkbox"/> Customize

## REMINDERS

- ◆ Product information in this catalog is subject to change without notice, and is for reference only. Therefore, please contact GOTREND Technology to check for the latest information before practical application or usage of the products.
- ◆ This catalog contains only typical specifications, please contact GOTREND Technology for further details if you can not find special components or information you need in this catalogue. Please also approve our product specifications or transact the approval sheet for product specifications before ordering.
- ◆ This catalogue only applies to products purchased through GOTREND Technology or its official agencies. This catalogue does not apply to products that are purchased through other third parties.
- ◆ Please read Attention and CAUTION note (for storage, operating, rating, soldering, mounting and handling) in this catalog to ensure product proper usage.
- ◆ GOTREND Technology is not responsible for issues that occur related to the intellectual property rights or other rights of our company or a third party when you use a product listed in this catalog. GOTREND Technology do not grant license of these rights.
- ◆ Information and data provided in the brochure can and do vary in different applications, and actual performance may vary over time.
- ◆ "Delivery Specification" illustrating precautions for the specifications and safety of each product listed in this catalog is available and we strongly recommend to provide these delivery specifications with customers that use these products.
- ◆ For exporting of product in this catalog, please take note it may be a restricted item according to the "Foreign Exchange and Foreign Trade Control Law". In such cases, it is necessary to acquire export permission in accordance to this law.
- ◆ Any reproduction or extraction of the contents in this catalog is prohibited without prior permission from GOTREND Technology.
- ◆ Products listed in this catalog are intended for general electronic device usage under normal operation and use condition including telecommunication equipment, home appliances, sports equipment AV equipment, industrial machine, office equipment etc. Please take note that our products are not designed, intended or authorized for use in below mentioned applications unless explicitly agreed in writing between the parties to avoid product failure that could result in situation where personal injury or death could occur.

- (1) Aerospace/Aviation equipment
- (2) Atomic energy-related equipment
- (3) Disaster prevention/crime prevention equipment
- (4) Electric heating apparatus, burning equipment
- (5) Medical equipment
- (6) Military equipment
- (7) Power-generation control equipment
- (8) Public information-processing equipment
- (9) Safety equipment
- (10) Seabed equipment
- (11) Transportation control equipment
- (12) Transportation equipment (cars, electric trains, ships, etc.)
- (13) Other applications that are not considered general-purpose applications

- ◆ Our manufacturing sites fully compliance with requirement regarding the quality management system in the automotive industry under the IATF 16949 standard. GOTREND Technology respect individual agreements with reference to customer requirements and customer specific requirements (CSR). We will like to emphasize that only requirements mutually agreed upon will in implemented in our Quality Management System taking into consideration that IATF 16949 may appear to support the acceptance of unilateral requirements. We will only legally bind to this individually agreed upon agreement under the IATF 16949 standard.
- ◆ The product itself is a powder metallurgy product, so the structure is relatively fragile, and it should not be used for products that are easy to fall. In addition, when this product is assembled, it should avoid collision with the tool or mechanism shell. 
- ◆ It is not recommended to use hot air gun for disassembling of this product. When using of hot air gun to repair other parts, please also take note that long time or high temperature exposure of this product will also damage the inductance device. If you need to use the hot air gun to disassemble the product, it is recommended to adjust the hot air gun temperature to 380 deg.C±5 deg.C. The blower head of the hot air gun should be perpendicular and at least 1cm away from the product. After heating the product to the tin material melting point, use tweezers to remove the product from the PCB. 

<b>Product Series :</b> GSTV	<b>Brand :</b> GOTREND
<b>File Version :</b> GSTV-SERIES-AG-V1R0	<b>Editor :</b> Qiuyi Wu
<b>Established Date :</b> 2023.03.24	<b>Description :</b> High Current Inductor
<b>Latest Edit Date :</b> 2023.03.24	<b>Product Type :</b> <input checked="" type="checkbox"/> Standard <input type="checkbox"/> Customize

**Features & Application :**

- \* High performance ( Isat ) realized by metal dust core.
- \* Low loss realized with low DCR
- \* Capable of corresponding high frequency
- \* 100% lead ( Pb ) free meet RoHS standard
- \* DC / DC converter for CPU in Notebook PC
- \* **Qualified AEC-Q200**
- \* **Automotive and other high temperature , high reliability application.**

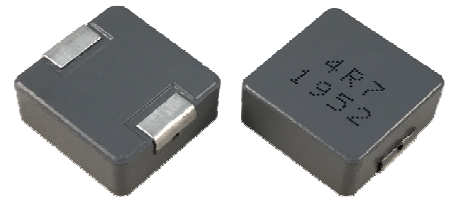

( Picture for reference only )

**Part No. Example :**

PN	:	<b>GSTV</b>	<b>7054</b>	<b>P</b>	-	<b>4R7</b>	<b>M</b>	-	<b>AG</b>
-----		-----	-----	---		-----	---		---
ID	:	1	2	3		4	5		6

- 1 : GOTREND Series : GSTV
- 2 : Type Size Code : 7054 = 7.9 x 7.3 x 5.2 mm
- 3 : Pb free < 1000ppm
- 4 : [ L ] Value : Inductance 4R7 = 4.7 uH
- 5 : [ L ] Tolerance : M = +/-20%
- 6 : [ AG ] : **Reliability is better than AEC-Q200 Grade 0 standard type.**

**Basic Information :**

<b>Made in</b>	China
<b>Pin Foot</b>	SMD
<b>Shielding</b>	Yes
<b>J-STD-020</b>	MSL Level 1
<b>RoHS</b>	Compliant
<b>REACH</b>	Compliant
<b>Halogen</b>	Free
<b>Automotive</b>	AEC Q200

**Operating & Storage Condition :**

- \* Operating Temp -55 ~ +165 deg.C ( Including self - tempersture rise )
- \* Storage Temp 1. -10 ~ +45 deg.C , 50 ~ 60% RH ( Without taping )  
2. -55 ~ +165 deg.C ( On board )
- \* Storage Life Time 6 Month ( Less than 40 deg.C and 60% RH )



**Attention & Caution :**

- \* Keep out of Splashing water or salt water
- \* Avoid Toxic Gas (Hydrogen sulfide, Sulfurous acid, Chlorine, Ammonia)
- \* Vibrations or shocks which exceed the specified condition
- \* Dew condense
- \* Layout near the edge of PCB
- \* Over flexure after SMT mounting & PCBA
- \* Pin foot or SMD pad solderability: Pb free type is best within 6 months after delivery
- \* Humidity sensitive , IPC/JEDEC J-STD-020 MSL if over Level 1, recommend bake 30mins@150 degree before PCBA
- \* Caution for human life relative applications : PLS contact & consult with GOTREND team in design stage.



**Test Condition :**



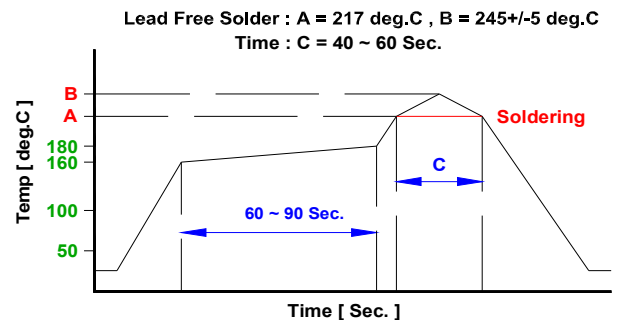

- \* Equipment HP4284A , HP42841A - L , Q , DCR , IDX  
HP8753D Network analyzer - SRF
- \* Standard Atmosphere Conditions:  
Ambient Temperature 20 ± 15 deg.C  
Humidity RH 65 ± 20%
- \* If there may be any doubt on the test result ,  
Measurement shall be made within the following limits:  
Ambient Temperature 25 ± 5 deg.C  
Humidity RH 75 ± 10%

**Recommend IR Reflow Curve : GTX-IR-FILE001**



**Notice : Iron Soldering , Solder < 30 Watt ,  
Direct touch the terminal x 3 Sec. Max. @ 350 deg.C**

**Product Series : GSTV****Brand : GOTREND****File Version : GSTV-SERIES-AG-V1R0****Editor : Qiuyi Wu****Established Date : 2023.03.24****Description : High Current Inductor****Latest Edit Date : 2023.03.24****Product Type :  Standard  Customize****SMD Power Inductor - GSTV Series Type**

Image	Part Name	A (mm)	B (mm)	C (mm)	Inductance Range (uH)	I <sub>rms</sub> (A)	I <sub>sat</sub> (A)	DCR ( m Ohm )	Page
	GSTV5030P	5.5	5.25	2.8	0.68 ~ 15.0	2.0 ~ 12.0	1.9 ~ 11.7	8.5 ~ 190.0	5-6
	GSTV6030P	7.1	6.6	2.8	0.47 ~ 22.0	2.4 ~ 19.0	2.5 ~ 19.0	3.4 ~ 16.5	7-8
	GSTV7054P	7.9	7.3	5.2	1.5 ~ 100.0	2.0 ~ 17.0	1.6 ~ 19.0	6.3 ~ 357.0	9-10
	GSTV1040P	11.0	10.0	3.8	0.47 ~ 47.0	3.2 ~ 34.0	3.6 ~ 31.0	1.42 ~ 165.0	11-13
	GSTV1054P	11.0	10.0	5.1	1.0 ~ 68.0	3.5 ~ 30.0	4.8 ~ 37.0	2.3 ~ 150.0	14-16

<b>Product Series :</b> GSTV	<b>Brand :</b> GOTREND
<b>File Version :</b> GSTV-SERIES-AG-V1R0	<b>Editor :</b> Qiuyi Wu
<b>Established Date :</b> 2023.03.24	<b>Description :</b> High Current Inductor
<b>Latest Edit Date :</b> 2023.03.24	<b>Product Type :</b> <input checked="" type="checkbox"/> Standard <input type="checkbox"/> Customize

### GSTV5030P-SERIES-AG

Dimension [ mm ] :

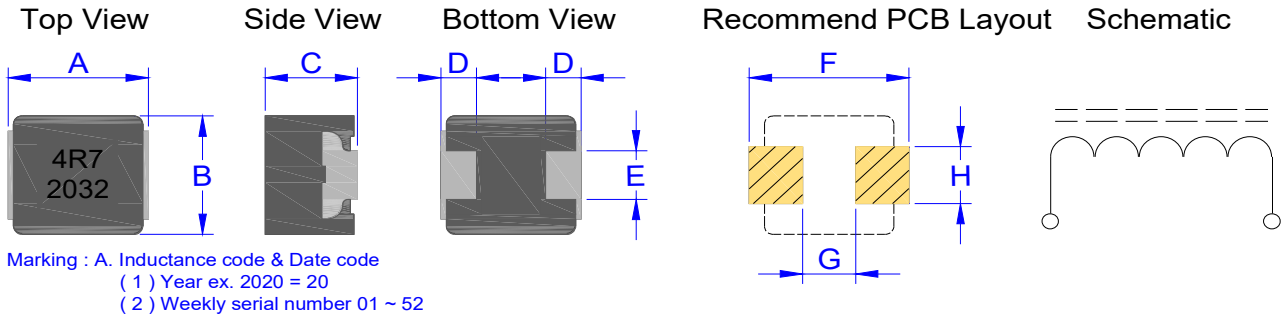

Size	A	B	C	D	E	F	G	H
GSTV5030P	5.5±0.3	5.25±0.2	2.8±0.2	1.3±0.3	3.0±0.3	6.70	2.1	3.5

Electrical Characteristics :

Part No.	Inductance ( uH )	Inductance Tolerance	I <sub>rms</sub> ( A )		I <sub>sat</sub> ( A )		DCR ( mΩ )	
			Typ.	Max.	Typ.	Max.	Typ.	Max.
GSTV5030P-R68M-AG	0.68	M	12.0	11.0	11.7	10.0	8.5	9.7
GSTV5030P-1R0M-AG	1.0	M	10.5	9.5	8.0	6.7	10.0	11.5
GSTV5030P-1R5M-AG	1.5	M	8.5	7.6	6.5	5.7	15.4	17.7
GSTV5030P-2R2M-AG	2.2	M	7.5	6.6	5.8	4.8	20.0	23.0
GSTV5030P-3R3M-AG	3.3	M	6.0	5.5	5.4	4.5	31.0	36.0
GSTV5030P-4R7M-AG	4.7	M	5.2	4.4	4.5	4.0	49.0	57.0
GSTV5030P-5R6M-AG	5.6	M	4.4	3.8	4.3	3.8	61.0	71.0
GSTV5030P-6R8M-AG	6.8	M	4.0	3.5	4.0	3.5	72.0	83.0
GSTV5030P-100M-AG	10.0	M	3.0	2.5	2.4	2.0	97.0	111.0
GSTV5030P-150M-AG	15.0	M	2.5	2.0	2.2	1.9	165.0	190.0

\* Test Condition @100KHz , 1.0V<sub>rms</sub> , 25 deg.C Ambient

\* Inductance Tolerance : M = +/-20%

\* I<sub>rms</sub> : Rated Current Loading when temperature rise approximately 40 deg.C

\* I<sub>sat</sub> : Saturated Current measured at the point of L drop approximately 30%

\* The parts final operating temperature ( Ambient + The parts temperature rise ) should not exceed 165 deg.C if under worst case of operating conditions.

Circuit design, component placement, PCB trace size and thickness, airflow and other cooling provision all affect the part temperature. Part temperature should be verified in the end application.

\* All test data is referenced to 25 deg.C Ambient.

<b>Product Series :</b> GSTV	<b>Brand :</b> GOTREND
<b>File Version :</b> GSTV-SERIES-AG-V1R0	<b>Editor :</b> Qiuyi Wu
<b>Established Date :</b> 2023.03.24	<b>Description :</b> High Current Inductor
<b>Latest Edit Date :</b> 2023.03.24	<b>Product Type :</b> <input checked="" type="checkbox"/> Standard <input type="checkbox"/> Customize

**Typical Performance Curves:**

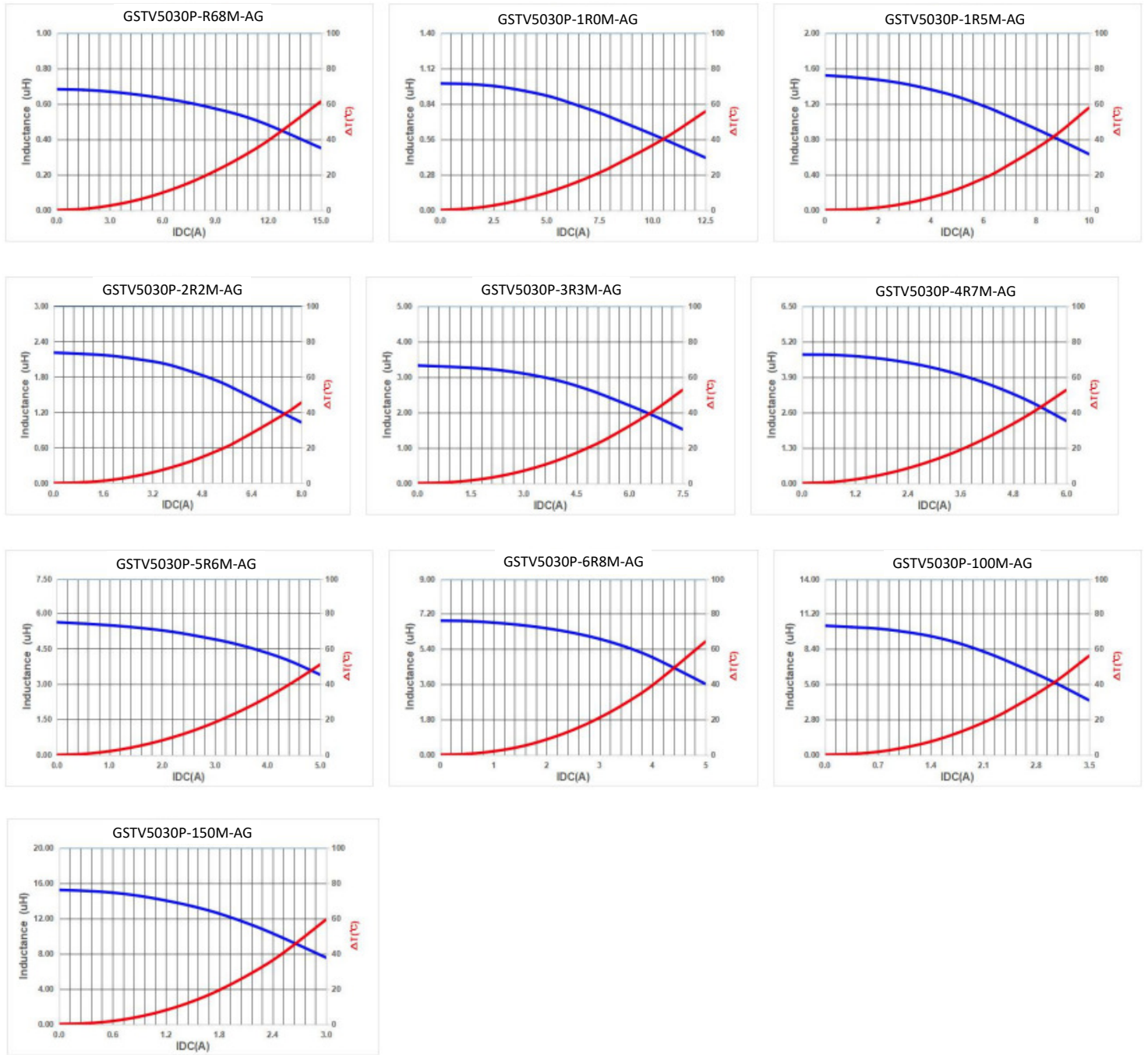

<b>Product Series :</b> GSTV	<b>Brand :</b> GOTREND
<b>File Version :</b> GSTV-SERIES-AG-V1R0	<b>Editor :</b> Qiuyi Wu
<b>Established Date :</b> 2023.03.24	<b>Description :</b> High Current Inductor
<b>Latest Edit Date :</b> 2023.03.24	<b>Product Type :</b> <input checked="" type="checkbox"/> Standard <input type="checkbox"/> Customize

### GSTV6030P-SERIES-AG

#### Dimension [ mm ] :

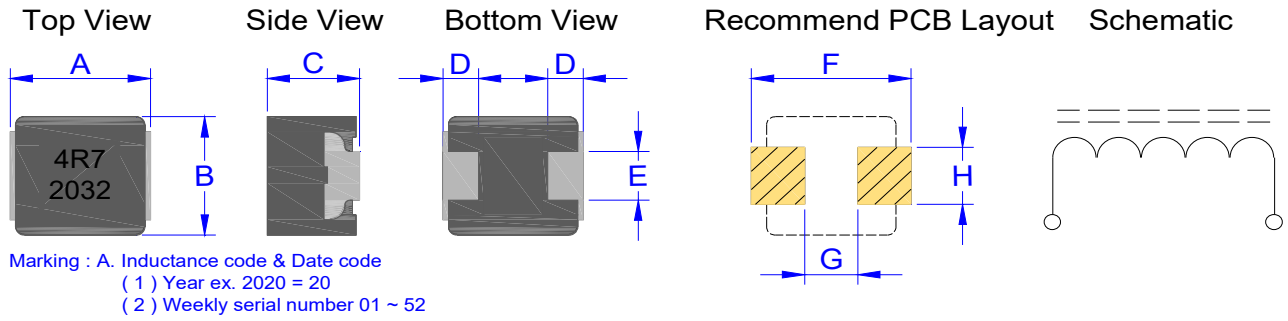

Size	A	B	C	D	E	F	G	H
GSTV6030P	7.1±0.3	6.6±0.2	2.8±0.2	1.8±0.3	3.0±0.2	8.4	2.7	3.4

#### Electrical Characteristics :

Part No.	Inductance ( uH )	Inductance Tolerance	I <sub>rms</sub> ( A )		I <sub>sat</sub> ( A )		DCR ( mΩ )	
			Typ.	Max.	Typ.	Max.	Typ.	Max.
GSTV6030P-R47M-AG	0.47	M	19.0	17.0	19.0	17.0	3.4	3.74
GSTV6030P-1R0M-AG	1.0	M	14.0	12.5	14.0	12.5	6.0	6.6
GSTV6030P-1R5M-AG	1.5	M	11.5	10.0	13.0	12.0	10.6	11.7
GSTV6030P-2R2M-AG	2.2	M	9.0	8.0	10.5	9.5	15.0	16.5
GSTV6030P-3R3M-AG	3.3	M	7.8	6.6	9.5	8.1	22.0	24.2
GSTV6030P-4R7M-AG	4.7	M	6.4	5.5	7.2	6.2	29.0	32.0
GSTV6030P-6R8M-AG	6.8	M	5.2	4.5	6.1	5.5	42.0	46.2
GSTV6030P-8R2M-AG	8.2	M	4.8	4.0	5.6	4.5	49.0	54.0
GSTV6030P-100M-AG	10.0	M	4.2	3.7	4.7	4.0	63.0	69.3
GSTV6030P-150M-AG	15.0	M	3.7	3.2	4.0	3.2	100.0	110.0
GSTV6030P-220M-AG	22.0	M	2.9	2.4	3.0	2.5	150.0	165.0

\* Test Condition @100KHz , 1.0V<sub>rms</sub> , 25 deg.C Ambient

\* Inductance Tolerance : M = +/-20%

\* I<sub>rms</sub> : Rated Current Loading when temperature rise approximately 40 deg.C

\* I<sub>sat</sub> : Saturated Current measured at the point of L drop approximately 30%

\* The parts final operating temperature ( Ambient + The parts temperature rise ) should not exceed 165 deg.C if under worst case of operating conditions.

Circuit design, component placement, PCB trace size and thickness, airflow and other cooling provision all affect the part temperature. Part temperature should be verified in the end application.

\* All test data is referenced to 25 deg.C Ambient.

<b>Product Series :</b> GSTV	<b>Brand :</b> GOTREND
<b>File Version :</b> GSTV-SERIES-AG-V1R0	<b>Editor :</b> Qiuyi Wu
<b>Established Date :</b> 2023.03.24	<b>Description :</b> High Current Inductor
<b>Latest Edit Date :</b> 2023.03.24	<b>Product Type :</b> <input checked="" type="checkbox"/> Standard <input type="checkbox"/> Customize

**Typical Performance Curves:**

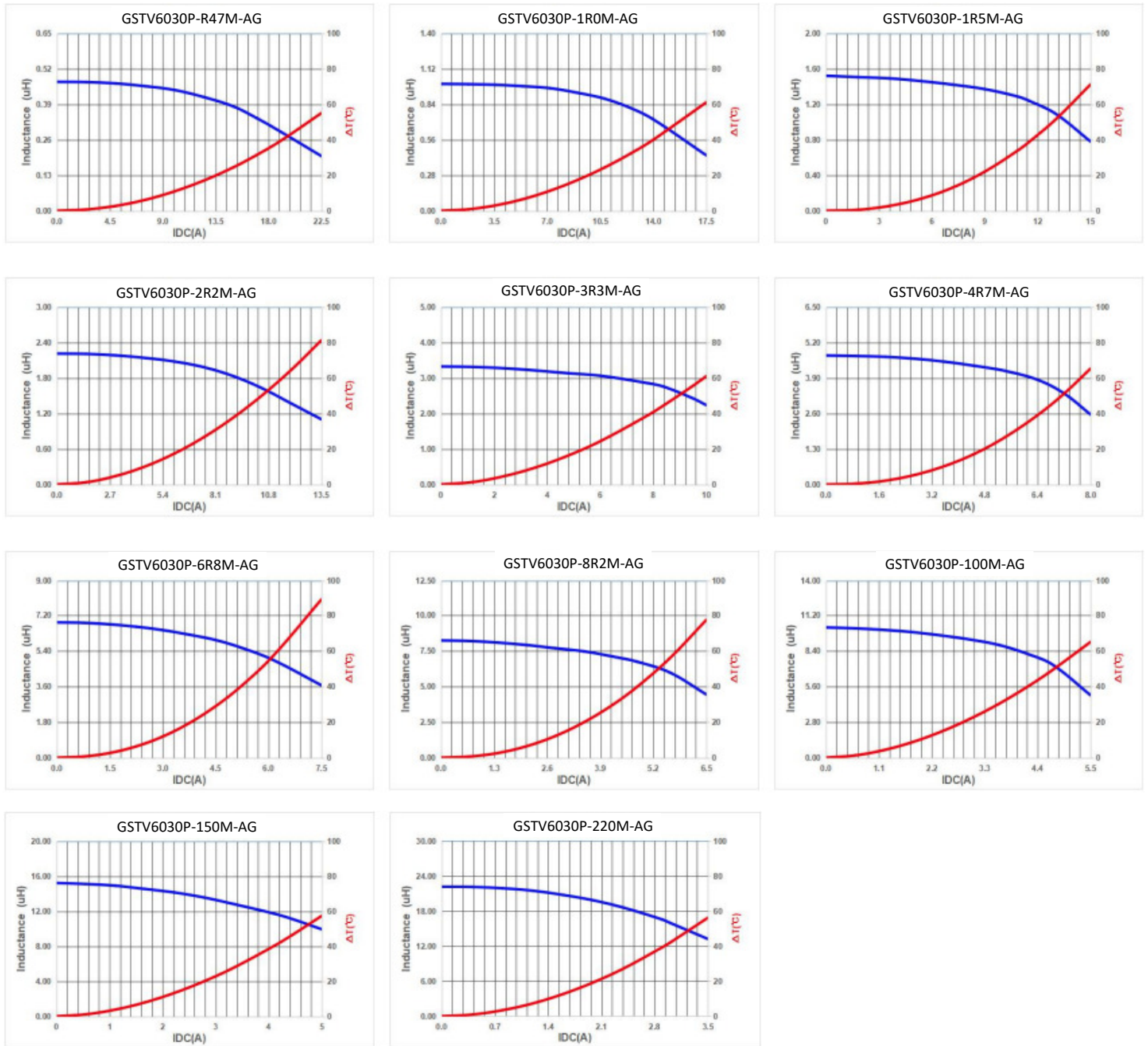



<b>Product Series :</b> GSTV	<b>Brand :</b> GOTREND
<b>File Version :</b> GSTV-SERIES-AG-V1R0	<b>Editor :</b> Qiuyi Wu
<b>Established Date :</b> 2023.03.24	<b>Description :</b> High Current Inductor
<b>Latest Edit Date :</b> 2023.03.24	<b>Product Type :</b> <input checked="" type="checkbox"/> Standard <input type="checkbox"/> Customize

### GSTV7054P-SERIES-AG

Dimension [ mm ] :

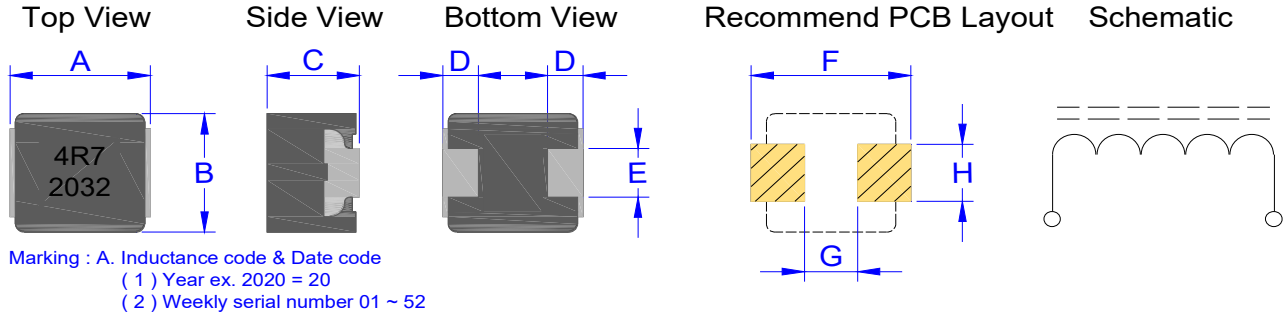

Size	A	B	C	D	E	F	G	H
GSTV7054P	7.9±0.3	7.3±0.2	5.2±0.2	2.0±0.3	3.0±0.2	9.0	3.0	3.5

### Electrical Characteristics :

Part No.	Inductance ( uH )	Inductance Tolerance	Irms ( A )		Isat ( A )		DCR ( mΩ )	
			Typ.	Max.	Typ.	Max.	Typ.	Max.
GSTV7054P-1R5M-AG	1.5	M	17.0	15.0	19.0	17.0	6.3	7.3
GSTV7054P-2R2M-AG	2.2	M	14.5	13.0	16.5	14.5	9.7	11.2
GSTV7054P-3R3M-AG	3.3	M	11.5	10.5	14.0	12.3	13.0	15.0
GSTV7054P-4R7M-AG	4.7	M	10.5	9.0	13.3	11.3	17.8	20.5
GSTV7054P-5R6M-AG	5.6	M	9.3	8.5	11.0	9.5	19.2	22.1
GSTV7054P-6R8M-AG	6.8	M	8.7	8.0	10.2	9.0	23.0	26.5
GSTV7054P-8R2M-AG	8.2	M	8.0	7.5	9.2	8.1	27.3	31.4
GSTV7054P-100M-AG	10.0	M	7.2	6.7	8.0	7.0	33.0	38.0
GSTV7054P-150M-AG	15.0	M	5.5	5.0	7.2	6.2	60.0	66.0
GSTV7054P-220M-AG	22.0	M	5.0	4.5	6.3	5.4	85.0	93.5
GSTV7054P-330M-AG	33.0	M	4.0	3.5	4.9	4.2	111.0	127.6
GSTV7054P-470M-AG	47.0	M	3.2	2.7	4.1	3.5	156.0	171.6
GSTV7054P-680M-AG	68.0	M	2.7	2.4	3.0	2.6	218.0	251.0
GSTV7054P-101M-AG	100.0	M	2.2	2.0	2.0	1.6	310.0	357.0

\* Test Condition @100KHz , 1.0Vrms , 25 deg.C Ambient

\* Inductance Tolerance : M = +/-20%

\* Irms : Rated Current Loading when temperature rise approximately 40 deg.C

\* Isat : Saturated Current measured at the point of L drop approximately 30%

\* The parts final operating temperature ( Ambient + The parts temperature rise ) should not exceed 165 deg.C if under worst case of operating conditions.

Circuit design, component placement, PCB trace size and thickness, airflow and other cooling provision all affect the part temperature. Part temperature should be verified in the end application.

\* All test data is referenced to 25 deg.C Ambient.

<b>Product Series :</b> GSTV	<b>Brand :</b> GOTREND
<b>File Version :</b> GSTV-SERIES-AG-V1R0	<b>Editor :</b> Qiuyi Wu
<b>Established Date :</b> 2023.03.24	<b>Description :</b> High Current Inductor
<b>Latest Edit Date :</b> 2023.03.24	<b>Product Type :</b> <input checked="" type="checkbox"/> Standard <input type="checkbox"/> Customize

**Typical Performance Curves:**

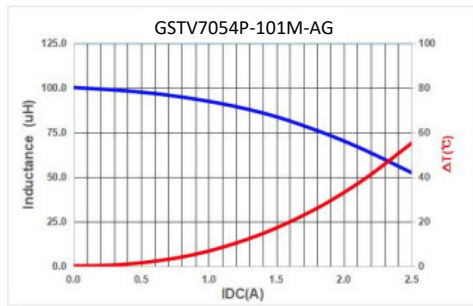
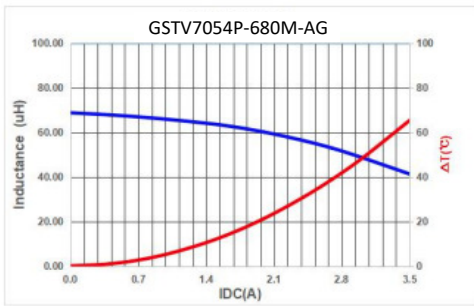
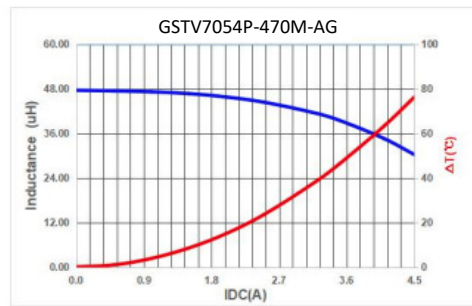
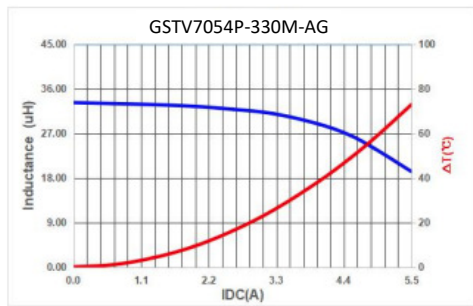
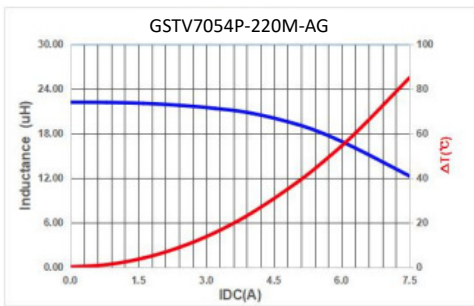
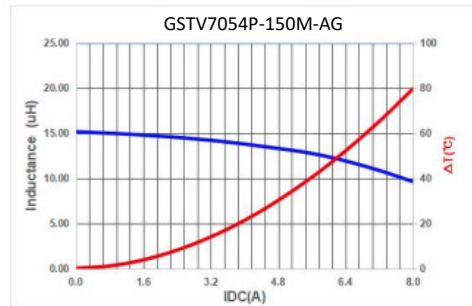
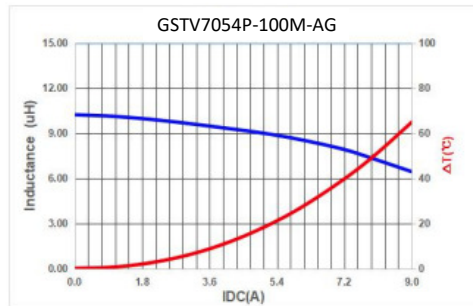
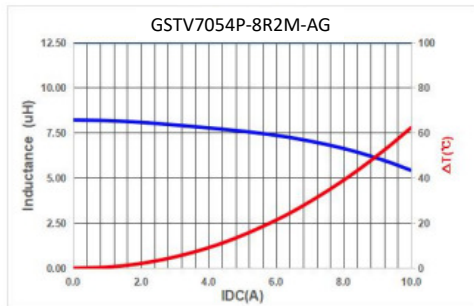
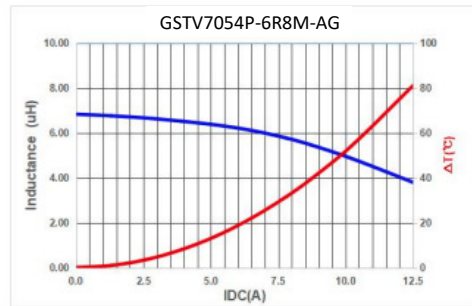
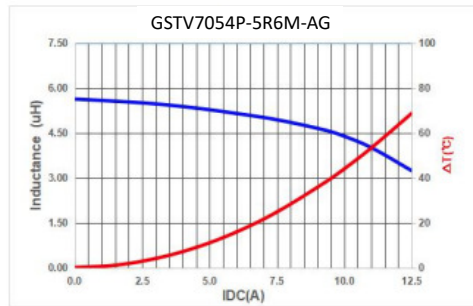
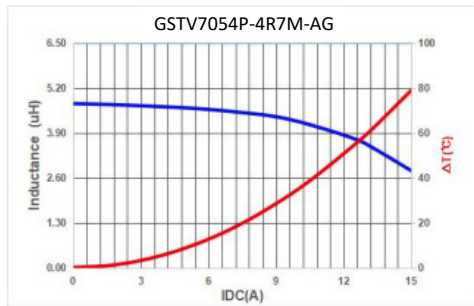
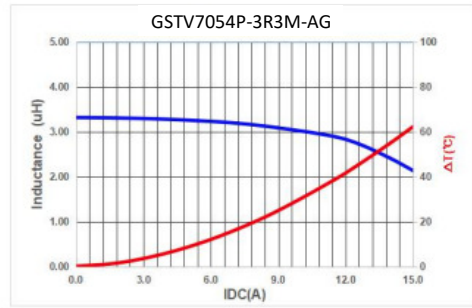
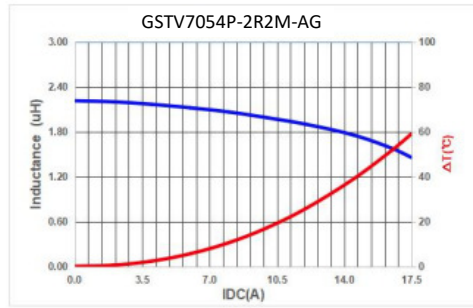
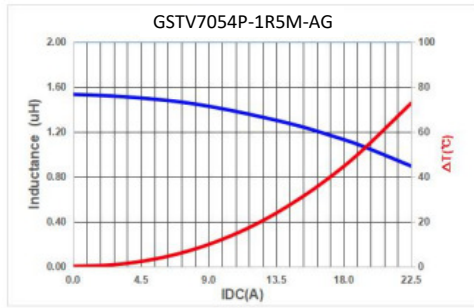

<b>Product Series :</b> GSTV	<b>Brand :</b> GOTREND
<b>File Version :</b> GSTV-SERIES-AG-V1R0	<b>Editor :</b> Qiuyi Wu
<b>Established Date :</b> 2023.03.24	<b>Description :</b> High Current Inductor
<b>Latest Edit Date :</b> 2023.03.24	<b>Product Type :</b> <input checked="" type="checkbox"/> Standard <input type="checkbox"/> Customize

### GSTV1040P-SERIES-AG

Dimension [ mm ] :

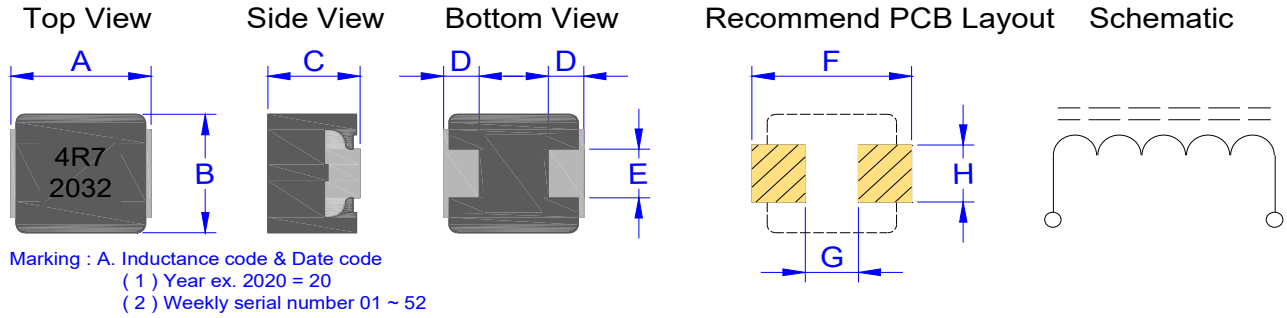

Size	A	B	C	D	E	F	G	H
GSTV1040P	11.0±0.3	10.0±0.3	3.8±0.2	2.3±0.3	4.5±0.3	12.3	5.5	5

### Electrical Characteristics :

Part No.	Inductance ( uH )	Inductance Tolerance	Irms ( A )		Isat ( A )		DCR ( mΩ )	
			Typ.	Max.	Typ.	Max.	Typ.	Max.
GSTV1040P-R47M-AG	0.47	M	34.0	29.0	31.0	28.0	1.42	1.63
GSTV1040P-R56M-AG	0.56	M	32.0	27.0	29.0	27.0	1.7	2.0
GSTV1040P-R68M-AG	0.68	M	31.0	26.0	28.0	26.0	2.0	2.3
GSTV1040P-R78M-AG	0.78	M	30.0	25.0	27.0	25.0	2.3	2.5
GSTV1040P-R82M-AG	0.82	M	27.0	23.0	26.5	24.0	2.4	2.7
GSTV1040P-1R0M-AG	1.0	M	25.0	21.0	26.0	23.0	2.7	3.1
GSTV1040P-1R5M-AG	1.5	M	22.0	19.0	24.0	21.0	3.9	4.5
GSTV1040P-1R8M-AG	1.8	M	20.0	17.0	23.0	20.0	4.4	5.5
GSTV1040P-2R2M-AG	2.2	M	18.0	16.0	19.0	17.0	5.3	6.1
GSTV1040P-3R3M-AG	3.3	M	15.0	13.0	17.0	15.0	9.0	10.4
GSTV1040P-4R7M-AG	4.7	M	11.0	10.0	13.5	11.5	13.4	15.0
GSTV1040P-5R6M-AG	5.6	M	10.5	9.5	12.0	10.5	15.4	17.0
GSTV1040P-6R8M-AG	6.8	M	10.0	9.5	11.0	10.0	17.0	19.0
GSTV1040P-8R2M-AG	8.2	M	8.5	7.7	9.0	8.0	23.0	25.3
GSTV1040P-100M-AG	10.0	M	8.0	7.2	8.2	7.5	27.0	30.0
GSTV1040P-120M-AG	12.0	M	7.4	6.8	7.5	6.9	29.0	33.4
GSTV1040P-150M-AG	15.0	M	6.4	6.0	7.0	6.3	40.0	45.0
GSTV1040P-220M-AG	22.0	M	5.5	5.0	6.0	5.5	59.0	68.0
GSTV1040P-330M-AG	33.0	M	4.7	3.7	4.8	4.1	89.0	102.0
GSTV1040P-470M-AG	47.0	M	3.6	3.2	4.0	3.6	143.0	165.0

\* Test Condition @100KHz , 1.0Vrms , 25 deg.C Ambient

\* Inductance Tolerance : M = +/-20%

\* Irms : Rated Current Loading when temperature rise approximately 40 deg.C

\* Isat : Saturated Current measured at the point of L drop approximately 30%

\* The parts final operating temperature ( Ambient + The parts temperature rise ) should not exceed 165 deg.C if under worst case of operating conditions.

Circuit design, component placement, PCB trace size and thickness, airflow and other cooling provision all affect the part temperature. Part temperature should be verified in the end application.

\* All test data is referenced to 25 deg.C Ambient.

<b>Product Series :</b> GSTV	<b>Brand :</b> GOTREND
<b>File Version :</b> GSTV-SERIES-AG-V1R0	<b>Editor :</b> Qiuyi Wu
<b>Established Date :</b> 2023.03.24	<b>Description :</b> High Current Inductor
<b>Latest Edit Date :</b> 2023.03.24	<b>Product Type :</b> <input checked="" type="checkbox"/> Standard <input type="checkbox"/> Customize

**Typical Performance Curves:**

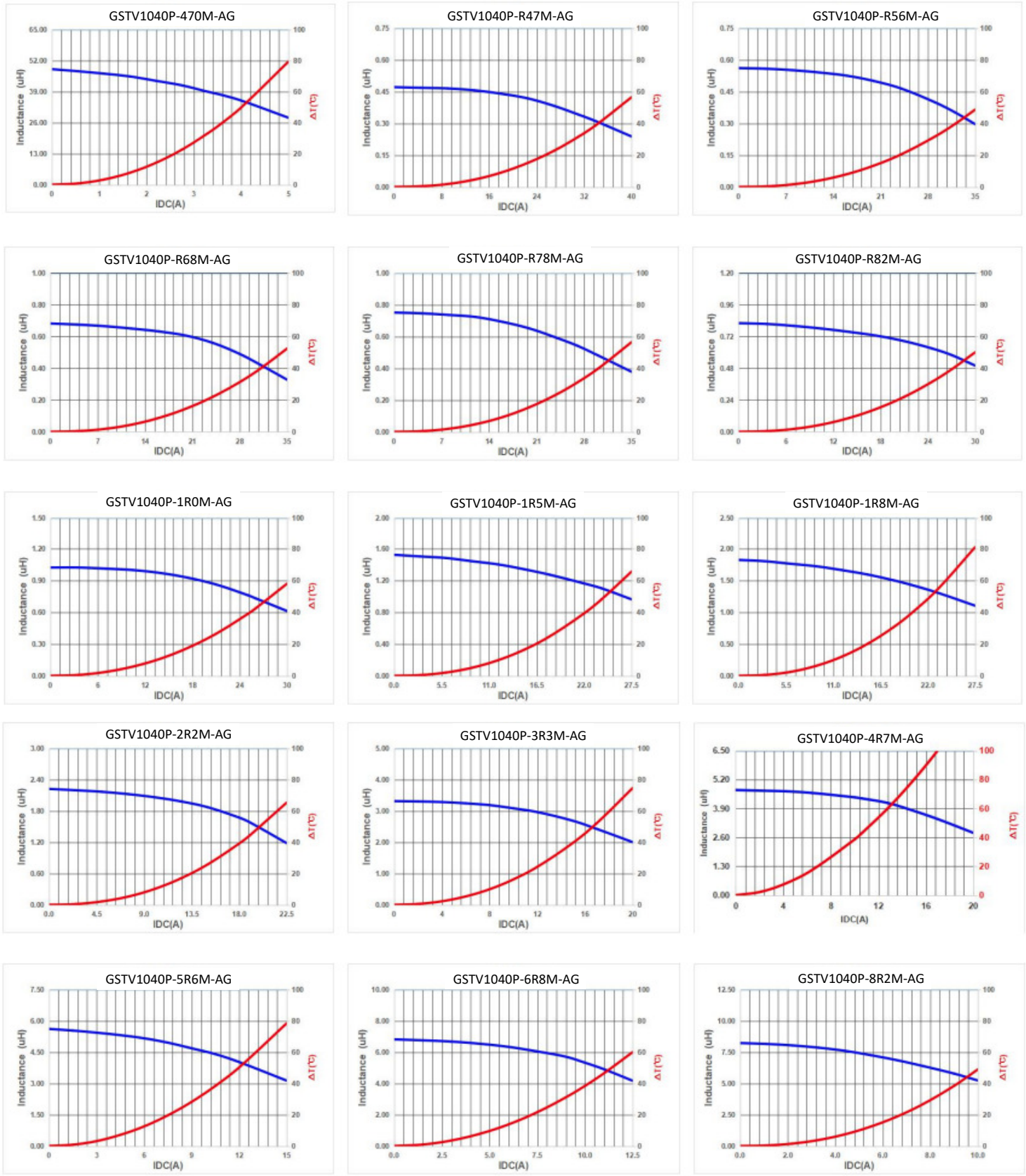

<b>Product Series :</b> GSTV	<b>Brand :</b> GOTREND
<b>File Version :</b> GSTV-SERIES-AG-V1R0	<b>Editor :</b> Qiuyi Wu
<b>Established Date :</b> 2023.03.24	<b>Description :</b> High Current Inductor
<b>Latest Edit Date :</b> 2023.03.24	<b>Product Type :</b> <input checked="" type="checkbox"/> Standard <input type="checkbox"/> Customize

**Typical Performance Curves:**

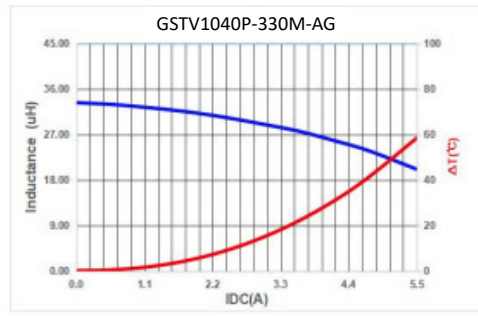
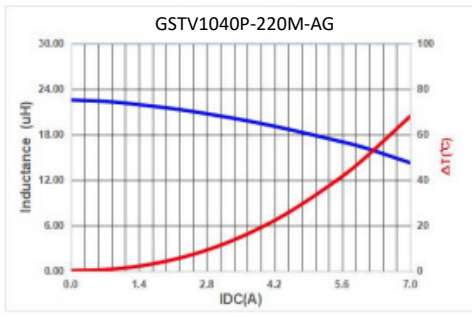
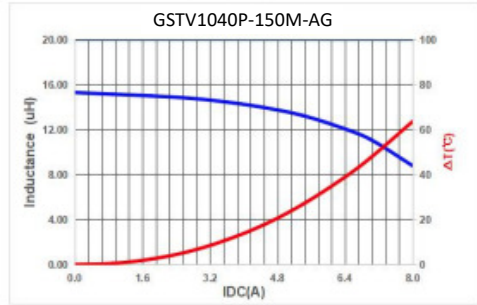
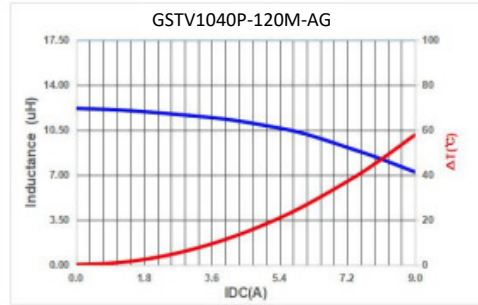
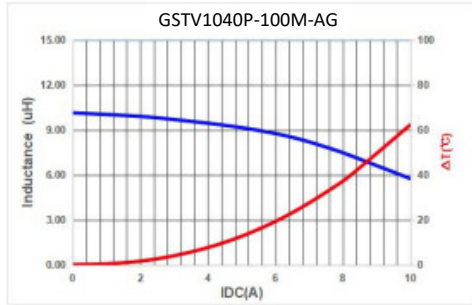

<b>Product Series :</b> GSTV	<b>Brand :</b> GOTREND
<b>File Version :</b> GSTV-SERIES-AG-V1R0	<b>Editor :</b> Qiuyi Wu
<b>Established Date :</b> 2023.03.24	<b>Description :</b> High Current Inductor
<b>Latest Edit Date :</b> 2023.03.24	<b>Product Type :</b> <input checked="" type="checkbox"/> Standard <input type="checkbox"/> Customize

### GSTV1054P-SERIES-AG

Dimension [ mm ] :

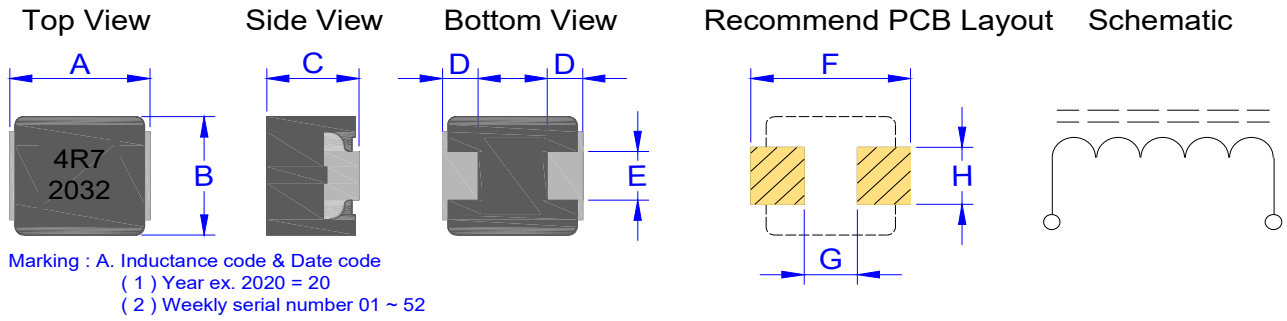

Size	A	B	C	D	E	F	G	H
GSTV1054P	11.0±0.3	10.0±0.3	5.1±0.3	2.3±0.3	4.5±0.3	12.3	5.5	5.0

### Electrical Characteristics :

Part No.	Inductance ( uH )	Inductance Tolerance	Irms ( A )	Isat ( A )	DCR ( mΩ )	
			Typ.	Typ.	Typ.	Max.
GSTV1054P-1R0M-AG	1.0	M	30.0	37.0	2.3	2.76
GSTV1054P-1R2M-AG	1.2	M	27.0	29.0	3.0	3.6
GSTV1054P-1R5M-AG	1.5	M	25.0	28.0	3.6	4.3
GSTV1054P-1R8M-AG	1.8	M	24.0	26.0	3.9	4.6
GSTV1054P-2R2M-AG	2.2	M	23.0	25.0	4.1	4.9
GSTV1054P-3R3M-AG	3.3	M	18.7	20.0	6.2	7.2
GSTV1054P-4R7M-AG	4.7	M	14.5	17.0	9.0	10.0
GSTV1054P-5R6M-AG	5.6	M	13.2	16.2	10.2	11.7
GSTV1054P-6R8M-AG	6.8	M	12.3	15.3	12.4	14.0
GSTV1054P-8R2M-AG	8.2	M	10.3	14.0	17.8	20.5
GSTV1054P-100M-AG	10.0	M	9.0	13.0	20.0	23.0
GSTV1054P-120M-AG	12.0	M	8.3	9.8	23.0	26.4
GSTV1054P-150M-AG	15.0	M	7.6	9.2	26.3	30.3
GSTV1054P-180M-AG	18.0	M	7.0	9.0	33.0	38.0
GSTV1054P-220M-AG	22.0	M	6.0	8.8	43.5	50.0
GSTV1054P-330M-AG	33.0	M	5.0	7.6	66.0	75.3
GSTV1054P-470M-AG	47.0	M	4.2	5.5	89.0	103.0
GSTV1054P-680M-AG	68.0	M	3.5	4.8	130.0	150.0

\* Test Condition @100KHz , 1.0Vrms , 25 deg.C Ambient

\* Inductance Tolerance : M = +/-20%

\* Irms : Rated Current Loading when temperature rise approximately 40 deg.C

\* Isat : Saturated Current measured at the point of L drop approximately 30%

\* The parts final operating temperature ( Ambient + The parts temperature rise ) should not exceed 165 deg.C if under worst case of operating conditions.

Circuit design, component placement, PCB trace size and thickness, airflow and other cooling provision all affect the part temperature. Part temperature should be verified in the end application.

\* All test data is referenced to 25 deg.C Ambient.

<b>Product Series :</b> GSTV	<b>Brand :</b> GOTREND
<b>File Version :</b> GSTV-SERIES-AG-V1R0	<b>Editor :</b> Qiuyi Wu
<b>Established Date :</b> 2023.03.24	<b>Description :</b> High Current Inductor
<b>Latest Edit Date :</b> 2023.03.24	<b>Product Type :</b> <input checked="" type="checkbox"/> Standard <input type="checkbox"/> Customize

**Typical Performance Curves:**

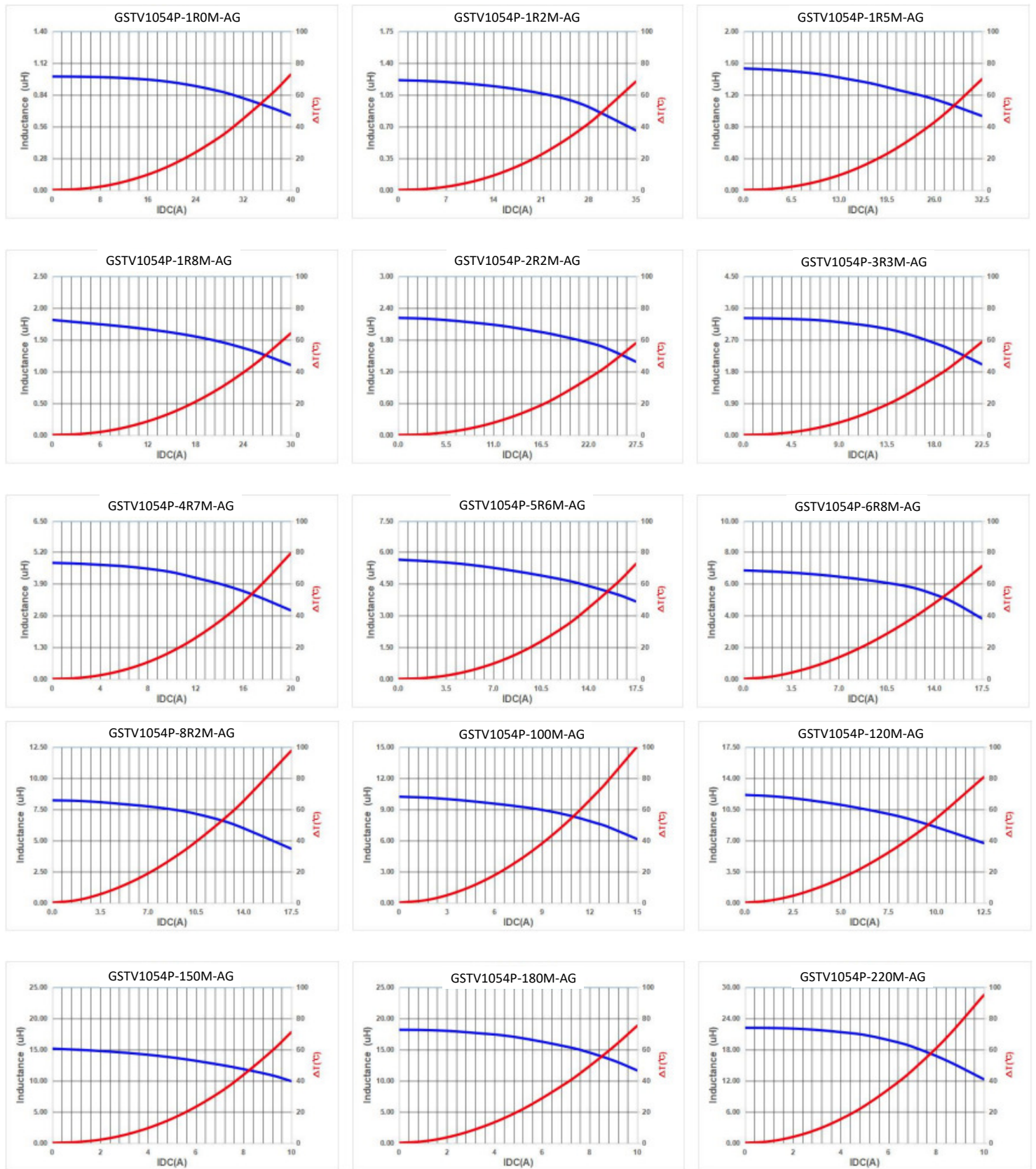

<b>Product Series :</b> GSTV	<b>Brand :</b> GOTREND
<b>File Version :</b> GSTV-SERIES-AG-V1R0	<b>Editor :</b> Qiuyi Wu
<b>Established Date :</b> 2023.03.24	<b>Description :</b> High Current Inductor
<b>Latest Edit Date :</b> 2023.03.24	<b>Product Type :</b> <input checked="" type="checkbox"/> Standard <input type="checkbox"/> Customize

**Typical Performance Curves:**

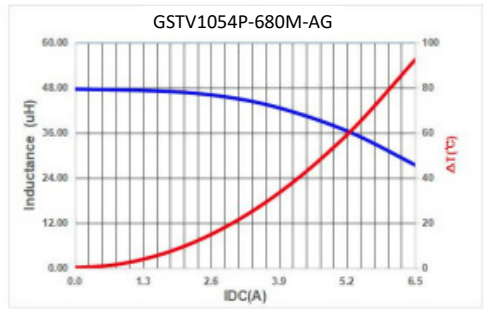
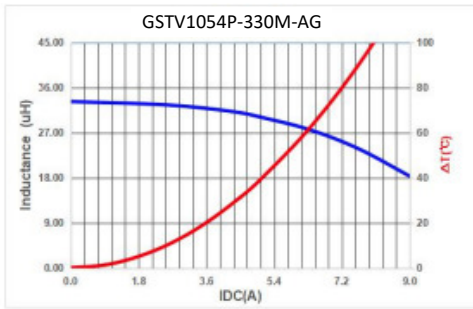
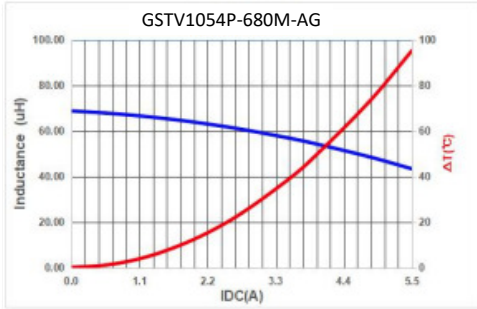



<b>Product Series :</b> GSTV	<b>Brand :</b> GOTREND
<b>File Version :</b> GSTV-SERIES-AG-V1R0	<b>Editor :</b> Qiuyi Wu
<b>Established Date :</b> 2023.03.24	<b>Description :</b> High Current Inductor
<b>Latest Edit Date :</b> 2023.03.24	<b>Product Type :</b> <input checked="" type="checkbox"/> Standard <input type="checkbox"/> Customize

### Care note :

Care note for Use :

(1) Storage Condition :

Temperature 25 to 35 deg.C, Humidity 45 to 60% RH

(2) Use Temperature :

a. Minimum Temperature : -55 deg.C Ambient temperature of power choke coil.

b. Maximum Temperature : +165 deg.C The value of temperature including ambient of the transformer and temperature rise of power choke coil.

c. There is not a problem from -55 deg.C ~ +165 deg.C in a reliability test.

d. However, this is not meant a temperature grade guarantee of UL.

(3) Model :

When this power choke coil was used in a similar or new product to the original one, sometimes it might be unable to satisfy the specifications due to difference of condition of usage.

(4) Drop :

If the power choke coil suffered mechanical stress such as drop, characteristics may become poor ( due to damage on coil bobbin, etc. ).

Never use such stressed power choke coil.

Care note for Safety :

(1) Provision to Abnormal Condition :

This power choke coil itself does not have any protective function in abnormal condition such as overload, short-circuit and open-circuit conditions, etc.

Therefore, it shall be confirmed as the end product that there is no risk of smoking, fire, dielectric withstand voltage, insulation resistance, etc. in abnormal conditions to provide protective devices and /or protection circuit in the end product.

(2) Temperature Rise :

Temperature rise of power choke coil depends on the installation condition on end products.

It shall be confirmed on the actual end product that temperature rise of power choke coil is in the limit of specified temperature class.

(3) Dielectric Strength :

Dielectric withstanding test with higher voltage than specific value will damage insulating material and shorten its life.

(4) Water :

This power choke coil must not be used in wet condition by water, coffee or any liquid because insulation strength becomes very low on the condition.

(5) Potting :

If this power choke coil is potted in some compound, coating material of magnet wire might be occasionally damaged. Please ask us if you intend to pot this power choke coil.

(6) Detergent :

Please consult our company once in case of this because the confirmation of reliability etc. is needed when the washing medicine is used for the power choke coil.

<b>Product Series :</b> GSTV	<b>Brand :</b> GOTREND
<b>File Version :</b> GSTV-SERIES-AG-V1R0	<b>Editor :</b> Qiuyi Wu
<b>Established Date :</b> 2023.03.24	<b>Description :</b> High Current Inductor
<b>Latest Edit Date :</b> 2023.03.24	<b>Product Type :</b> <input checked="" type="checkbox"/> Standard <input type="checkbox"/> Customize

**Reliability :**

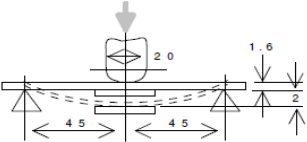
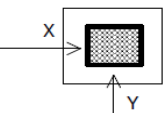
SN	Test Item	Test Condition	Specification
1	<b>External Visual</b> MIL-STD-883 Method 2009	Inspect device construction and workmanship. Electrical test not required.	There is no change for appearance ( electrode did not fall off , loose , no breakage , ferrite core did not break , damage )
2	<b>Physical Dimension</b> JESD22 Method JB-100	Verify physical dimensions to the device specification.	For Spec.
3	<b>Thermal Shock</b> MIL-STD-202 Method 107	Temperature : -55± 2 deg.C ~ +165± 2 deg.C Max transfer time : 20 s. Dwell time : 15 minutes. Air - Air	There is no change for appearance ( electrode did not fall off , loose , no breakage , ferrite core did not break , damage ) Inductor value / resistance change rate ± 10%.
4	<b>Humidity Resistance</b> MIL-STD-202 Method 103	Humidity : 85% RH Temperature : 85 deg.C Test time : 1000 Hours	There is no change for appearance ( electrode did not fall off , loose , no breakage , ferrite core did not break , damage ) Inductor value / resistance change rate ± 10%.
5	<b>High Temperature</b> MIL-STD-202 Method 108	Temperature: 165± 2 deg.C Test time: 1000 Hours	There is no change for appearance ( electrode did not fall off , loose , no breakage , ferrite core did not break , damage ) Inductor value / resistance change rate ± 10%.
6	<b>Temperature and Humidity Cycle</b> JESD22 Method JA-104	Temperature :-55 deg.C ~ +165 deg.C Cycles : 1000	There is no change for appearance ( electrode did not fall off , loose , no breakage , ferrite core did not break , damage ) Inductor value / resistance change rate ± 10%.
7	<b>Operational Life</b> MIL-PRF-27	Temperature : 165 deg.C Load : Allowed DC current Test time: 1000 Hours	No short circuit , open circuit.
8	<b>Vibration</b> MIL-STD-202 Method 204	5 g' s for 20 minutes , 12 cycles each of 3 orientations. Test from 10Hz ~ 2000Hz	No bad phenomenon.
9	<b>Mechanical Shock</b> MIL-STD-202 Method 213	Figure 1 of Method 213 SMD : Condition C.	No bad phenomenon.
10	<b>Resistance to Soldering Head</b> MIL-STD-202 Method 210	Condition B No pre-heat of samples. Temperature 250 up / 5 s. Temperature 183 up / 90 ~ 120 s.	Tin solder have to cover over 90% area.
11	<b>Solderability</b> J-STD-002	a. Method B , 4 Hours @ 155 deg.C dry heat @ 235 deg.C b. Method B @ 215 deg.C category 3 c. Method D @ 260 deg.C category 3	No change and transform form the appearance
12	<b>Board Flex</b> AETS		No change and transform form the appearance
13	<b>Terminal Streng</b> AETS	Force of 1.8 Kg for 60 s. 	Fulfil quality requirements.
14	<b>Resistance to Solvents</b> MIL-STD-202 Method 215	Note : Add Aqueous wash chemical-OKEM or equivalent. No banned substances.	Fulfil quality requirements.

<b>Product Series :</b> GSTV	<b>Brand :</b> GOTREND
<b>File Version :</b> GSTV-SERIES-AG-V1R0	<b>Editor :</b> Qiuyi Wu
<b>Established Date :</b> 2023.03.24	<b>Description :</b> High Current Inductor
<b>Latest Edit Date :</b> 2023.03.24	<b>Product Type :</b> <input checked="" type="checkbox"/> Standard <input type="checkbox"/> Customize

**Packaging Information :**

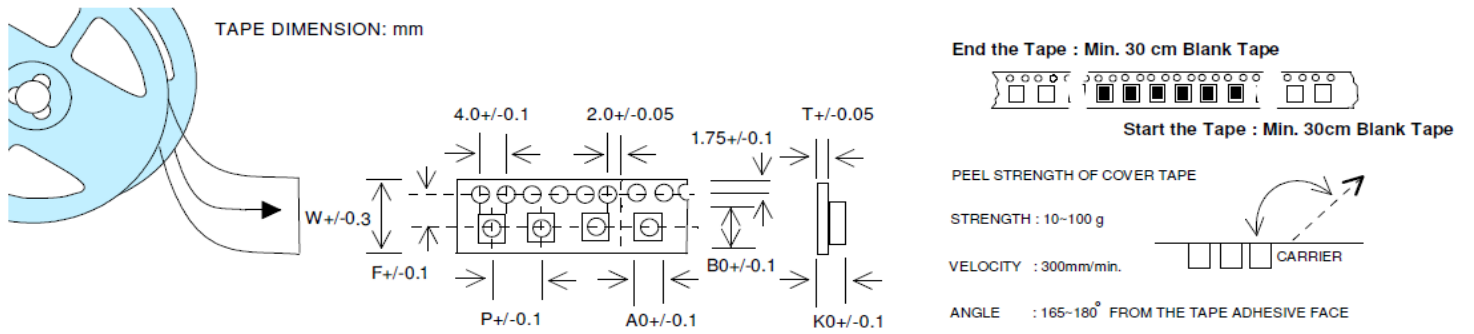

SIZE/mm	W	P	A0	B0	K0	T	F
5030	12.0	8.0	5.5	6.2	3.3	0.35	5.5
6030	16.0	12.0	7.1	8.1	3.3	0.35	7.5
7054	16.0	12.0	7.7	9.0	5.7	0.40	7.5
1040	24.0	16.0	10.4	12.3	4.5	0.40	11.5
1054	24.0	16.0	10.4	12.3	5.7	0.40	11.5

**Reel Dimension ( mm ) :**

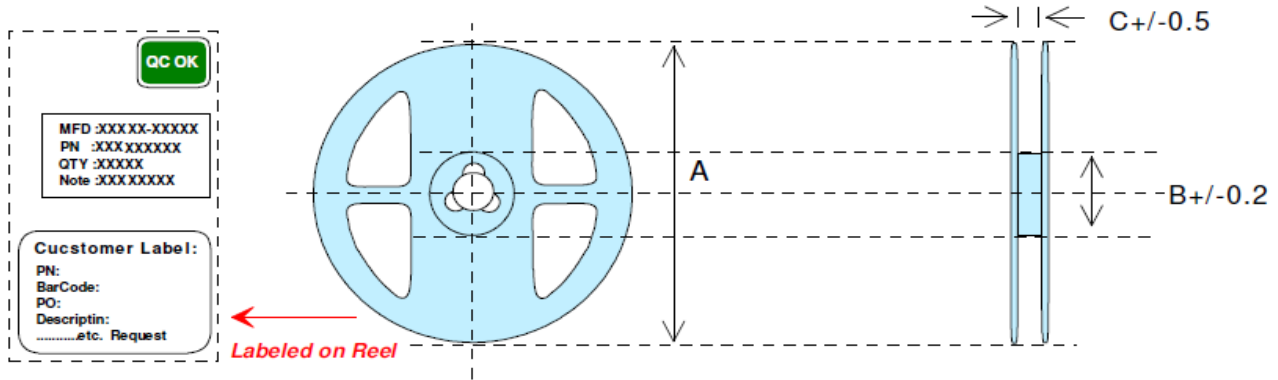

SIZE/mm	A	B	C	REEL SIZE	QTY / REE
5030	330	100	12.4	13"	2000 PCS
6030	330	100	16.4	13"	1000 PCS
7054	330	100	16.4	13"	800 PCS
1040	330	100	24.4	13"	500 PCS
1054	330	100	24.4	13"	500 PCS

<b>Product Series :</b> GSTV	<b>Brand :</b> GOTREND
<b>File Version :</b> GSTV-SERIES-AG-V1R0	<b>Editor :</b> Qiuyi Wu
<b>Established Date :</b> 2023.03.24	<b>Description :</b> High Current Inductor
<b>Latest Edit Date :</b> 2023.03.24	<b>Product Type :</b> <input checked="" type="checkbox"/> Standard <input type="checkbox"/> Customize

Tearing Off Force :

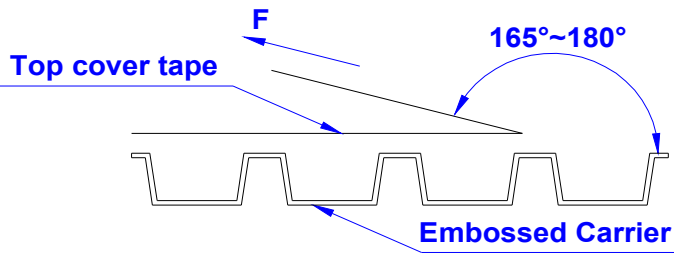

The force for tearing off cover tape is 10 to 130 grams in the arrow direction under the following conditions (referenced ANSI / EIA - 481 - D - 2008 of 4.11 standard).

Room Temp. ( deg.C )	Room Humidity ( % )	Room Atm. ( hPa )	Tearing Speed ( mm / min )
5 ~ 35	45 ~ 85	860 ~ 1060	300

Box Package :

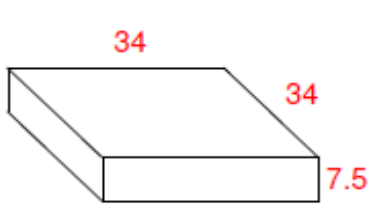

**Inner Small Box**

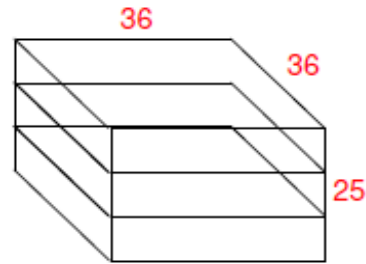

**Outer Large Box**

SIZE/mm	Reels in Small Box(QTY)	Small Box in Large Box(QTY)
5030	2(4000)	4(16000)
5030	2(2000)	4(8000)
7054	2(1600)	4(6400)
1040	2(1000)	4(4000)
1054	2(1000)	4(4000)