

Product Series :	GBDC	Brand :	GOTREND
File Version :	GBDC-SERIES-V1R2	Editor :	Qiuyi Wu
Established Date	2011.08.24	Description :	Multilayer Ferrite Common Mode
Latest Edit Date :	2023.07.12	Product Type :	<input checked="" type="checkbox"/> Standard <input type="checkbox"/> Customize

REMINDERS

- ◆ Product information in this catalog is subject to change without notice, and is for reference only. Therefore, please contact GOTREND Technology to check for the latest information before practical application or usage of the products.
- ◆ This catalog contains only typical specifications, please contact GOTREND Technology for further details if you can not find special components or information you need in this catalogue. Please also approve our product specifications or transact the approval sheet for product specifications before ordering.
- ◆ This catalogue only applies to products purchased through GOTREND Technology or its official agencies. This catalogue does not apply to products that are purchased through other third parties.
- ◆ Please read Attention and CAUTION note (for storage, operating, rating, soldering, mounting and handling) in this catalog to ensure product proper usage.
- ◆ GOTREND Technology is not responsible for issues that occur related to the intellectual property rights or other rights of our company or a third party when you use a product listed in this catalog. GOTREND Technology do not grant license of these rights.
- ◆ Information and data provided in the brochure can and do vary in different applications, and actual performance may vary over time.
- ◆ "Delivery Specification" illustrating precautions for the specifications and safety of each product listed in this catalog is available and we strongly recommend to provide these delivery specifications with customers that use these products.
- ◆ For exporting of product in this catalog, please take note it may be a restricted item according to the "Foreign Exchange and Foreign Trade Control Law". In such cases, it is necessary to acquire export permission in accordance to this law.
- ◆ Any reproduction or extraction of the contents in this catalog is prohibited without prior permission from GOTREND Technology.
- ◆ Products listed in this catalog are intended for general electronic device usage under normal operation and use condition including telecommunication equipment, home appliances, sports equipment AV equipment, industrial machine, office equipment etc. Please take note that our products are not designed, intended or authorized for use in below mentioned applications unless explicitly agreed in writing between the parties to avoid product failure that could result in situation where personal injury or death could occur.

- (1) Aerospace/Aviation equipment
- (2) Atomic energy-related equipment
- (3) Disaster prevention/crime prevention equipment
- (4) Electric heating apparatus, burning equipment
- (5) Medical equipment
- (6) Military equipment
- (7) Power-generation control equipment
- (8) Public information-processing equipment
- (9) Safety equipment
- (10) Seabed equipment
- (11) Transportation control equipment
- (12) Transportation equipment (cars, electric trains, ships, etc.)
- (13) Other applications that are not considered general-purpose applications

- ◆ Our manufacturing sites fully compliance with requirement regarding the quality management system in the automotive industry under the IATF 16949 standard. GOTREND Technology respect individual agreements with reference to customer requirements and customer specific requirements (CSR). We will like to emphasize that only requirements mutually agreed upon will in implemented in our Quality Management System taking into consideration that IATF 16949 may appear to support the acceptance of unilateral requirements. We will only legally bind to this individually agreed upon agreement under the IATF 16949 standard.

- ◆ The product itself is a powder metallurgy product, so the structure is relatively fragile, and it should not be used for products that are easy to fall. In addition, when this product is assembled, it should avoid collision with the tool or mechanism shell. 

- ◆ It is not recommended to use hot air gun for disassembling of this product. When using of hot air gun to repair other parts, please also take note that long time or high temperature exposure of this product will also damage the inductance device. If you need to use the hot air gun to disassemble the product, it is recommended to adjust the hot air gun temperature to 380 deg.C±5 deg.C. The blower head of the hot air gun should be perpendicular and at least 1cm away from the product. After heating the product to the tin material melting point, use tweezers to remove the product from the PCB. 

Product Series :	GBDC	Brand :	GOTREND
File Version :	GBDC-SERIES-V1R2	Editor :	Qiuyi Wu
Established Date	2011.08.24	Description :	Multilayer Ferrite Common Mode
Latest Edit Date :	2023.07.12	Product Type :	<input checked="" type="checkbox"/> Standard <input type="checkbox"/> Customize

Features & Application :

- * The GBDC series is effective for common mode noise suppression in digital equipment which causes radiation from cables.
- * Low leakage flux due to monolithic structure enables high-density mounting.
- * The nickel barrier structure of the external electrodes provides excellent solder heat resistance.
- * Prevention of common mode noise on signal line in personal computers , computer built in equipments , facsimiles , digital telephones , etc...

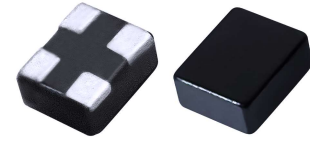

(Picture for reference only)

Part No. Example :

PN	:	GBDC	2012	P	-	900	N
-----		-----	-----	---		-----	---
ID	:	1	2	3		4	5
1	:	GBD : GOTREND Series					
2	:	2012 : Length 2.0 mm x Width 1.25 mm x Height 0.9 mm					
3	:	P : Pb < 1000ppm					
4	:	900 : Impedance (Ohm) = 90 Ohm					
5	:	N : Tolerance = Typ. or +/-25%					

Basic Information :

Made in	China
Pin Foot	SMD
Shielding	Yes
J-STD-020	MSL Level 1
RoHS	Compliant
REACH	Compliant
Halogen	Free

Operating & Storage Condition :

- * Operating Temp -25 ~ +85 deg.C (Size : 0605 / 0806) / -40 ~ +125 deg.C (Size : 2012) (Including self - temperature rise)
- * Storage Temp 1. -10 ~ +45 deg.C , 50 ~ 60% RH (Product with taping)
2. -25 ~ +85 deg.C (Size : 0605 / 0806) / -40 ~ +125 deg.C (Size : 2012) (On board)
- * Storage Life Time 6 Month (Less than 40 deg.C and 60% RH)

Attention & Caution :

- * Keep out of Splashing water or salt water
- * Avoid Toxic Gas (Hydrogen sulfide, Sulfurous acid, Chlorine, Ammonia)
- * Avoid Vibrations or shocks which exceed the specified condition
- * Avoid Dew condense
- * Avoid Layout near the edge of PCB
- * Avoid Over flexure after SMT mounting & PCBA

- * Pin foot or SMD pad solderability: Pb free type is best within 6 months after delivery
- * Humidity sensitive , IPC/JEDEC J-STD-020 MSL if over Level 1, recommend bake 30mins@150 degree before PCBA
- * Caution for human life relative applications : PLS contact & consult with GOTREND team in design stage.

Test Condition :

- * Equipment HP4284A , HP42841A - L , Q , DCR , IDC
HP8753D Network analyzer - SRF
- * Standard Atmosphere Conditions:
Ambient Temperature 20 ± 15 deg.C
Humidity RH 65 ± 20%
- * If there may be any doubt on the test result ,
Measurement shall be made within the following limits:
Ambient Temperature 25 ± 5 deg.C
Humidity RH 75 ± 10%

Recommend IR Reflow Curve : GTX-IR-FILE001



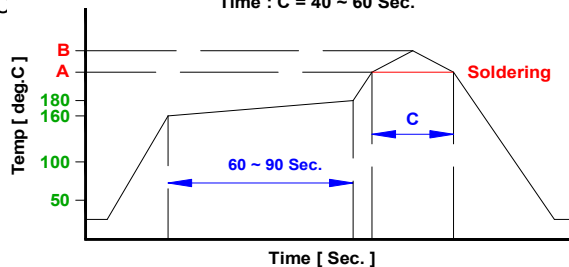











Lead Free Solder : A = 217 deg.C , B = 245+/-5 deg.C
Time : C = 40 ~ 60 Sec.



Notice : Iron Soldering , Solder < 30 Watt ,
Direct touch the terminal x 3 Sec. Max. @ 350 deg.C

Product Series : GBDC**Brand :** GOTREND**File Version :** GBDC-SERIES-V1R2**Editor :** Qiuyi Wu**Established Date :** 2011.08.24**Description :** Multilayer Ferrite Common Mode**Latest Edit Date :** 2023.07.12**Product Type :** Standard Customize

Multilayer Ferrite Common Mode - GBDC Series Type

Image	Part Name	L (mm) +/-0.05	W (mm) +/-0.05	H (mm) +/-0.05				DCR (Ohm) Typ.	Rated Voltage Vdc (V) Max.	Rated Current Idc (mA) Max.	Page
	GBDC0605PG	0.65	0.50	0.30	35		90	1.5 ~ 5.2	5	100	5
	GBDC0605PS	0.65	0.50	0.30	12			1.3 ~ 2.5	5	100	6
	GBDC0605PT	0.65	0.50	0.30	12			1.6 ~ 2.8	5	100	7
	GBDC0806PG	0.85	0.65	0.40	35		90	1.4 ~ 4.0	5	100	8
	GBDC0806PS	0.85	0.65	0.40	12		47	0.9 ~ 3.8	5	100	9 ~ 10
	GBDC0806PT	0.85	0.65	0.40	12			1.4~2.8	5	100	11
	GBDC2012P	2.00 +/-0.2	1.25 +/-0.2	0.90 +/-0.2	90		120	0.7 Max.	10	400	12

Product Series :	GBDC	Brand :	GOTREND
File Version :	GBDC-SERIES-V1R2	Editor :	Qiuyi Wu
Established Date	2011.08.24	Description :	Multilayer Ferrite Common Mode
Latest Edit Date :	2023.07.12	Product Type :	<input checked="" type="checkbox"/> Standard <input type="checkbox"/> Customize

GBDC0605PG-SERIES

Dimension [mm] :

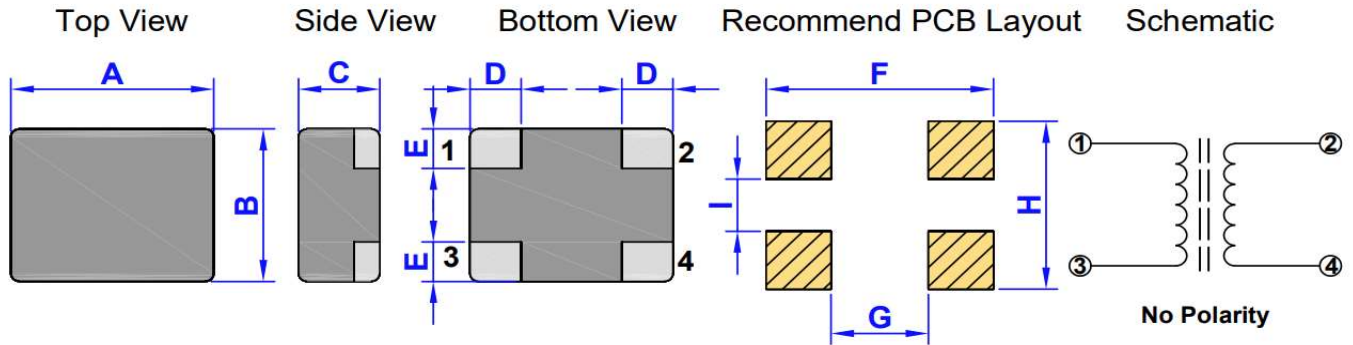

Size	A	B	C	D	E	F	G	H	I
0605PG	0.65±0.05	0.50±0.05	0.3±0.05	0.2±0.05	0.15±0.10	0.71	0.25	0.80	0.20

Electrical Characteristics :

Part No.	Common - Mode Impedance (Ω) at 100MHz (Under Standard Testing Condition)	DC Resistance (Ω)	Rated Voltage (V) Max.	Rated Current (mA) Max.	Insulation Resistance (M Ω) Min.	Differential Signal Cutoff Frequency @ - 3dB (GHz)
GBDC0605PG-350N	19 ~ 35	1.5 ~ 2.5	5	100	10	8
GBDC0605PG-900N	90 ± 25%	2.8 ~ 5.2	5	100	10	2.7

* Operating Temperature : - 25°C ~ 85°C

Insertion Loss (Ref.) :

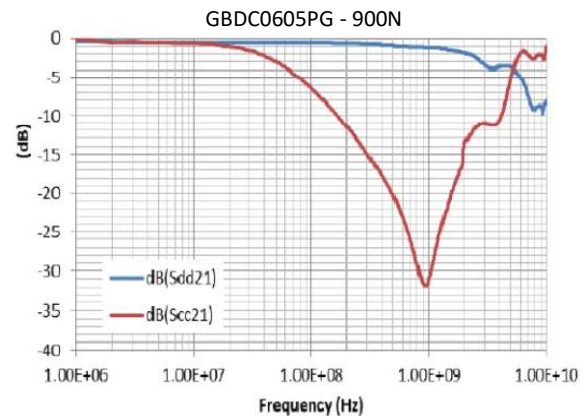
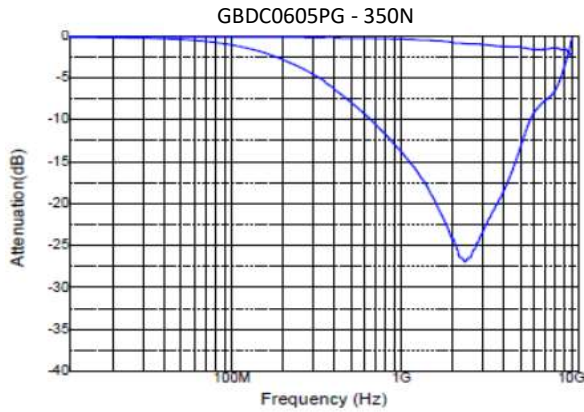

Product Series : GBDC	Brand : GOTREND
File Version : GBDC-SERIES-V1R2	Editor : Qiuyi Wu
Established Date : 2011.08.24	Description : Multilayer Ferrite Common Mode
Latest Edit Date : 2023.07.12	Product Type : <input checked="" type="checkbox"/> Standard <input type="checkbox"/> Customize

GBDC0605PS-SERIES

Dimension [mm] :

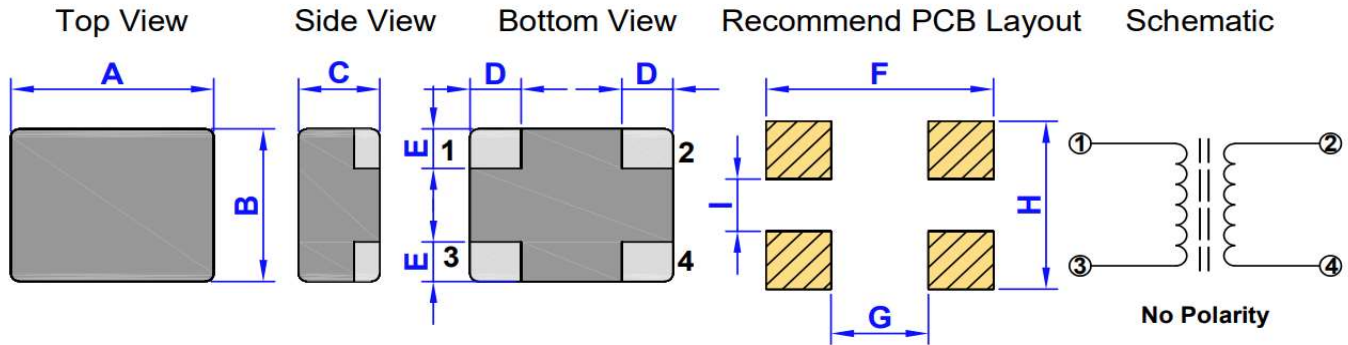

Size	A	B	C	D	E	F	G	H	I
0605PS	0.65±0.05	0.50±0.05	0.3±0.05	0.2±0.05	0.15±0.10	0.71	0.25	0.80	0.20

Electrical Characteristics :

Part No.	Common - Mode Impedance (Ω) at 100MHz (Under Standard Testing Condition)	DC Resistance (Ω)	Rated Voltage (V) Max.	Rated Current (mA) Max.	Insulation Resistance (M Ω) Min.	Differential Signal Cutoff Frequency @ - 3dB (GHz)
GBDC0605PS-120N	Max. 20	1.3 ~ 2.5	5	100	10	>10

* Operating Temperature : - 25°C ~ 85°C

Insertion Loss (Ref.) :

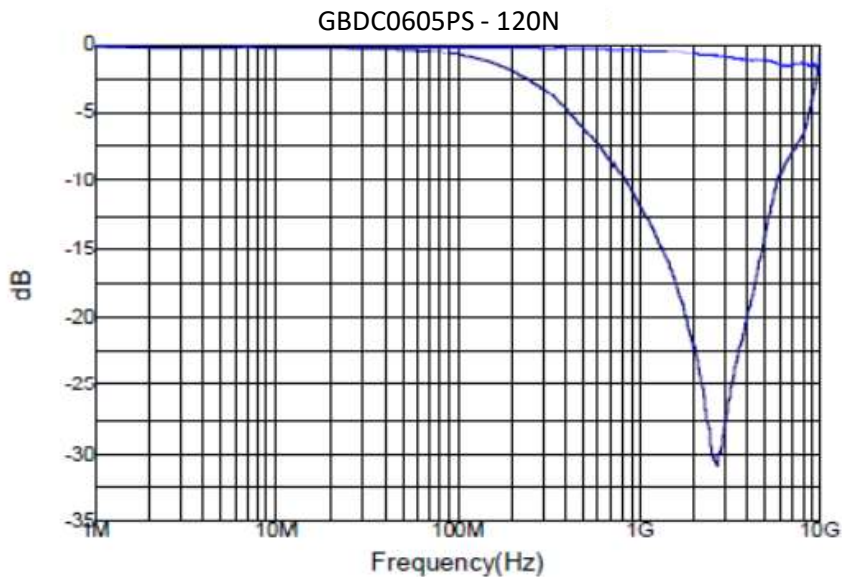

Product Series : GBDC	Brand : GOTREND
File Version : GBDC-SERIES-V1R2	Editor : Qiuyi Wu
Established Date : 2011.08.24	Description : Multilayer Ferrite Common Mode
Latest Edit Date : 2023.07.12	Product Type : <input checked="" type="checkbox"/> Standard <input type="checkbox"/> Customize

GBDC0605PT-SERIES

Dimension [mm] :

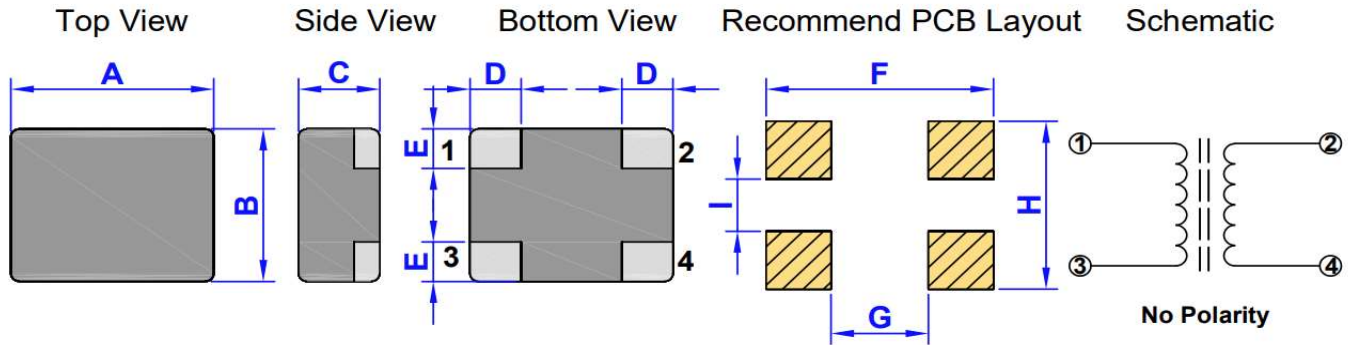

Size	A	B	C	D	E	F	G	H	I
0605PT	0.65±0.05	0.50±0.05	0.3±0.05	0.2±0.05	0.15±0.10	0.71	0.25	0.80	0.20

Electrical Characteristics :

Part No.	Common - Mode Impedance (Ω) at 100MHz (Under Standard Testing Condition)	DC Resistance (Ω)	Rated Voltage (V) Max.	Rated Current (mA) Max.	Insulation Resistance (M Ω) Min.	Differential Signal Cutoff Frequency @ - 3dB (GHz)
GBDC0605PT-120N	9 ~ 15	1.6 ~ 2.8	5	100	10	10

* Operating Temperature : - 25°C ~ 85°C

Insertion Loss (Ref.) :

GBDC0605PT - 120N

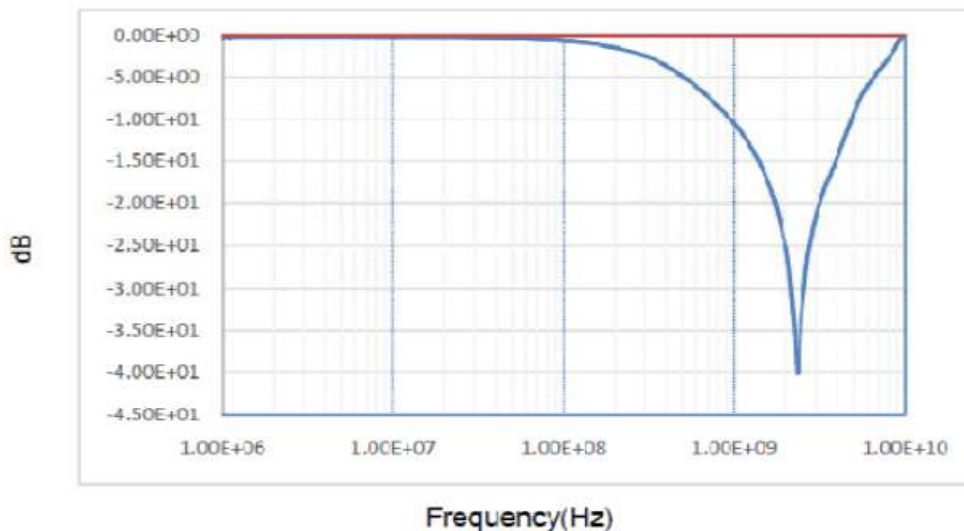

Product Series :	GBDC	Brand :	GOTREND
File Version :	GBDC-SERIES-V1R2	Editor :	Qiuyi Wu
Established Date	2011.08.24	Description :	Multilayer Ferrite Common Mode
Latest Edit Date :	2023.07.12	Product Type :	<input checked="" type="checkbox"/> Standard <input type="checkbox"/> Customize

GBDC0806PG-SERIES

Dimension [mm] :

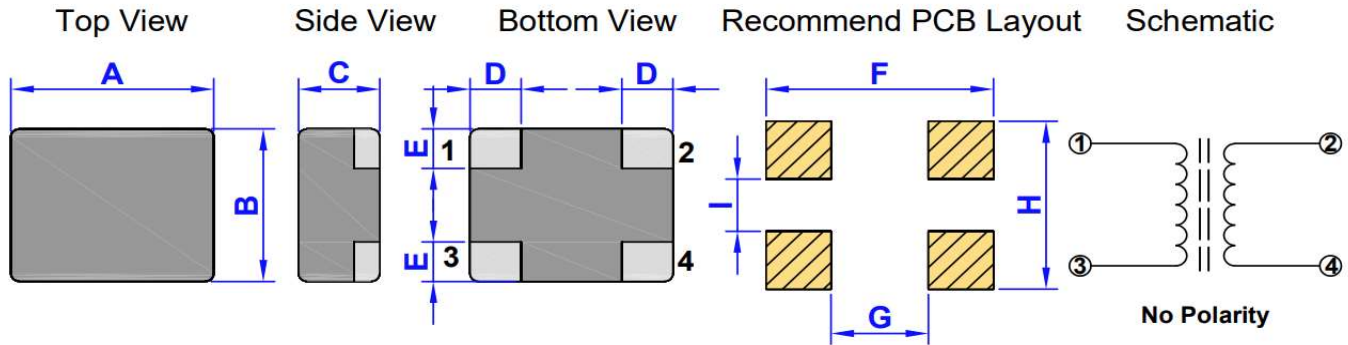

Size	A	B	C	D	E	F	G	H	I
0806PG	0.85±0.05	0.65±0.05	0.4±0.05	0.27 Typ.	0.20 Typ.	0.80	0.20	0.8~1.0	0.30

Electrical Characteristics :

Part No.	Common - Mode Impedance (Ω) at 100MHz (Under Standard Testing Condition)	DC Resistance (Ω)	Rated Voltage (V) Max.	Rated Current (mA) Max.	Insulation Resistance (M Ω) Min.
GBDC0806PG-350N	35 ± 25%	1.4 ~ 2.5	5	100	10
GBDC0806PG-900N	90 ± 25%	1.9 ~ 4.0	5	100	10

* Operating Temperature : - 25°C ~ 85°C

Insertion Loss (Ref.) :

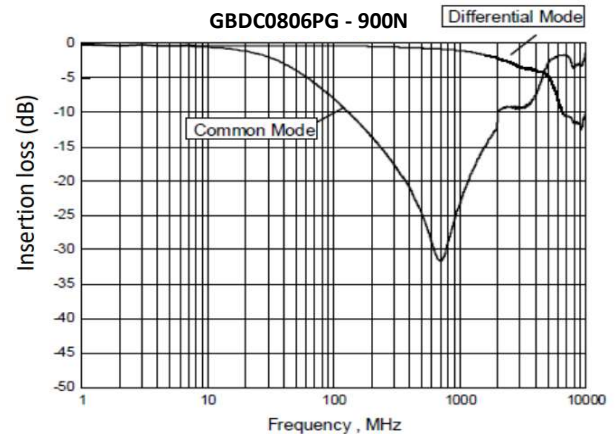
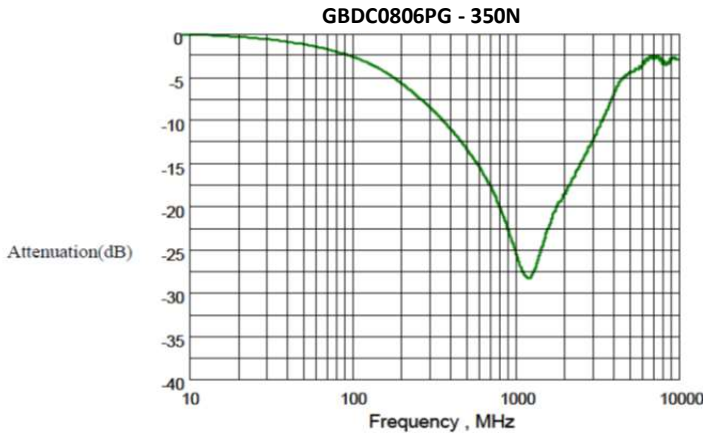

Product Series : GBDC	Brand : GOTREND
File Version : GBDC-SERIES-V1R2	Editor : Qiuyi Wu
Established Date : 2011.08.24	Description : Multilayer Ferrite Common Mode
Latest Edit Date : 2023.07.12	Product Type : <input checked="" type="checkbox"/> Standard <input type="checkbox"/> Customize

GBDC0806PS-SERIES

Dimension [mm] :

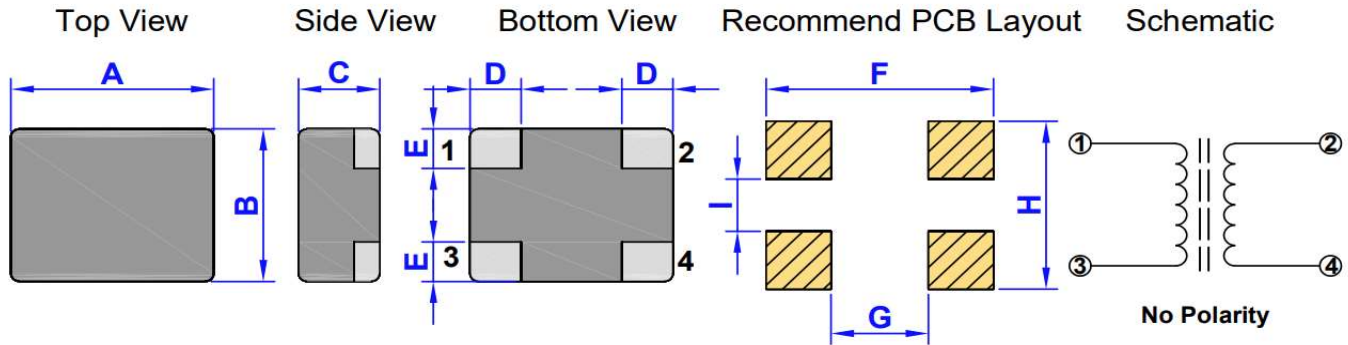

Size	A	B	C	D	E	F	G	H	I
0806PS	0.85±0.05	0.65±0.05	0.4±0.05	0.27 Typ.	0.20 Typ.	0.80	0.20	0.8~1.0	0.30

Electrical Characteristics :

Part No.	Common - Mode Impedance (Ω) at 100MHz (Under Standard Testing Condition)	DC Resistance (Ω)	Rated Voltage (V) Max.	Rated Current (mA) Max.	Insulation Resistance (M Ω) Min.
GBDC0806PS-120N	12 ± 25%	0.9 ~ 1.7	5	100	10
GBDC0806PS-250N	25 ± 25%	1.4 ~ 2.5	5	100	10
GBDC0806PS-470N	47 ± 25%	2.4 ~ 3.8	5	100	10

* Operating Temperature : - 25°C ~ 85°C

Product Series : GBDC
File Version : GBDC-SERIES-V1R2
Established Date 2011.08.24
Latest Edit Date : 2023.07.12

Brand : GOTREND
Editor : Qiuyi Wu
Description : Multilayer Ferrite Common Mode
Product Type : Standard Customize

GBDC0806PS-SERIES

Insertion Loss (Ref.) :

GBDC0806PS - 120N

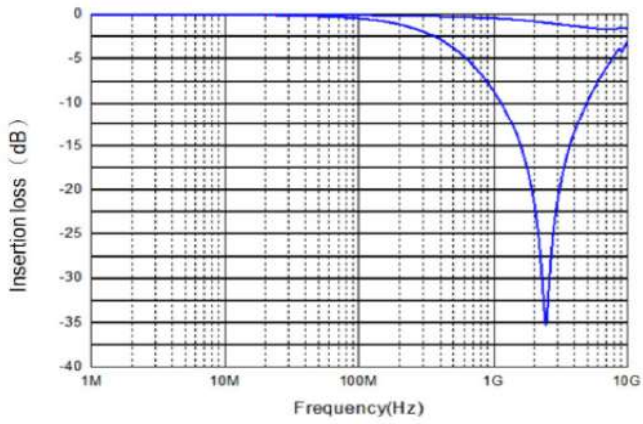

GBDC0806PS - 250N

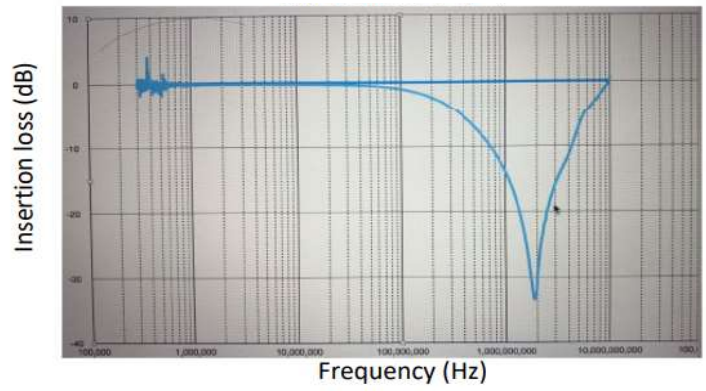

GBDC0806PS - 470N

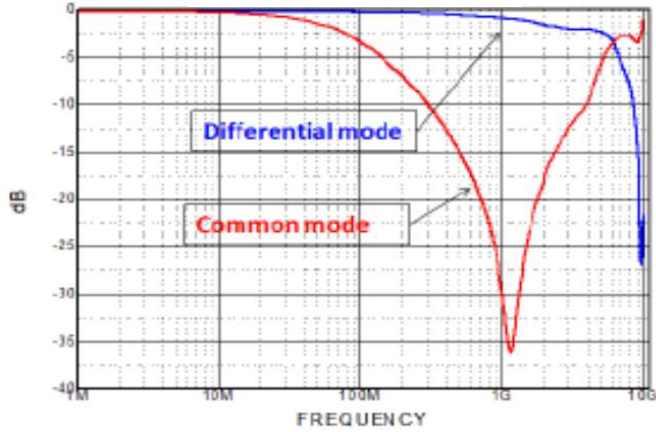

Product Series :	GBDC
File Version :	GBDC-SERIES-V1R2
Established Date	2011.08.24
Latest Edit Date :	2023.07.12

Brand :	GOTREND
Editor :	Qiuyi Wu
Description :	Multilayer Ferrite Common Mode
Product Type :	<input checked="" type="checkbox"/> Standard <input type="checkbox"/> Customize

GBDC0806PT-SERIES

Dimension [mm] :

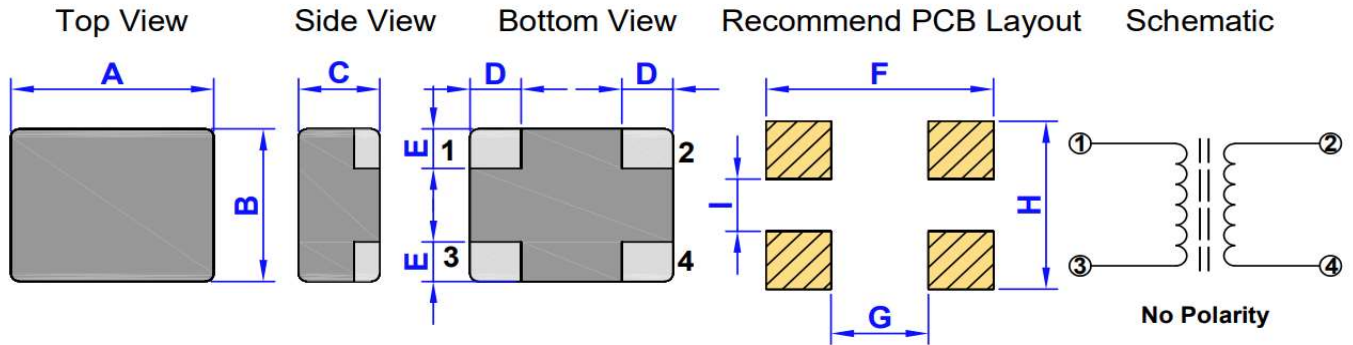

Size	A	B	C	D	E	F	G	H	I
0806PT	0.85±0.05	0.65±0.05	0.4±0.05	0.27 Typ.	0.20 Typ.	0.80	0.20	0.8~1.0	0.30

Electrical Characteristics :

Part No.	Common - Mode Impedance (Ω) at 100MHz	DC Resistance (Ω)	Rated Voltage (V) Max.	Rated Current (mA) Max.	Insulation Resistance (MΩ) Min.	Differential Signal Cutoff Frequency @ - 3dB (GHz) Min.
GBDC0806PT-120N	12 ~ 18	1.4 ~ 2.8	5	100	10	10

* Operating Temperature : - 25°C ~ 85°C

Insertion Loss (Ref.) :

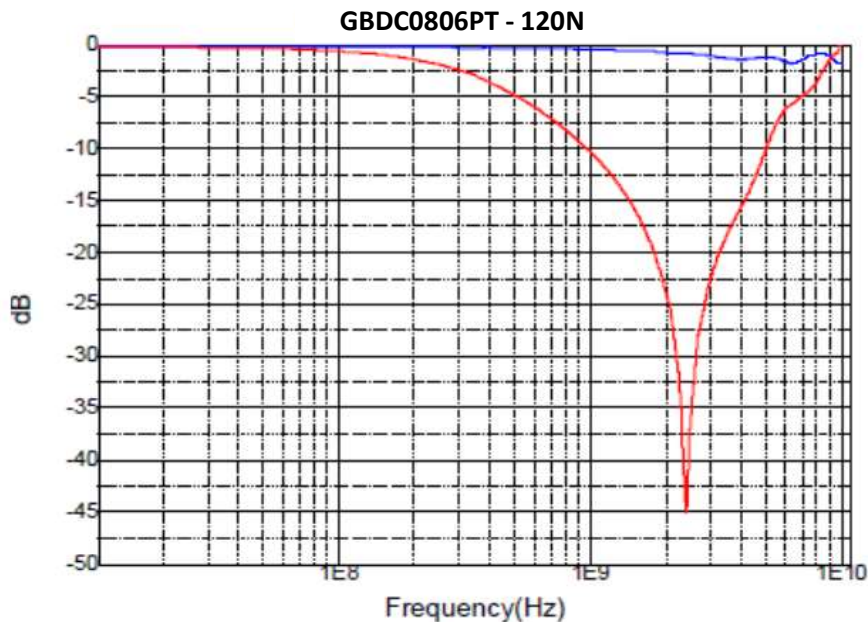

Product Series :	GBDC	Brand :	GOTREND
File Version :	GBDC-SERIES-V1R2	Editor :	Qiuyi Wu
Established Date	2011.08.24	Description :	Multilayer Ferrite Common Mode
Latest Edit Date :	2023.07.12	Product Type :	<input checked="" type="checkbox"/> Standard <input type="checkbox"/> Customize

GBDC2012P-SERIES

Dimension [mm] :

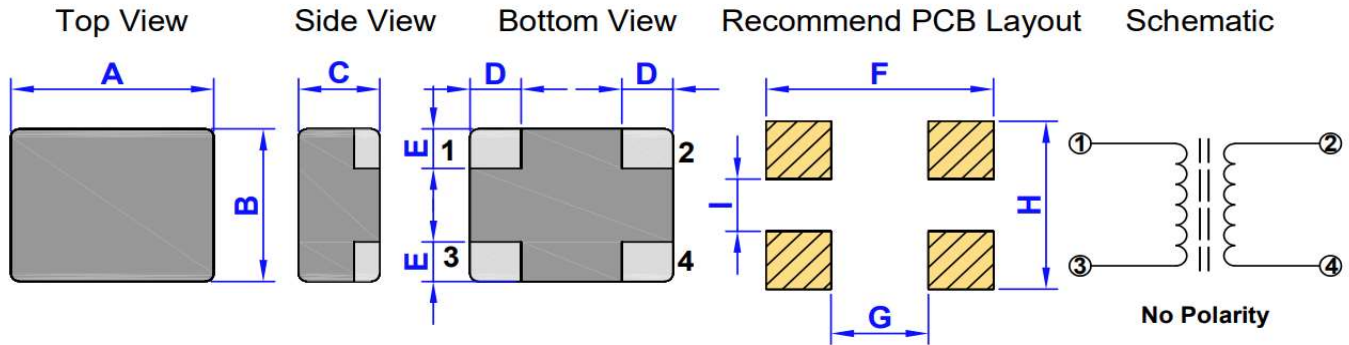

Size	A	B	C	D	E	F	G	H	I
2012P	2.00±0.20	1.25±0.20	0.9±0.20	0.40 Typ.	0.30 Typ.	2.40	1.45	1.65	0.90

Electrical Characteristics :

Part No.	Common - Mode Impedance (Ω)	Test Freq. (MHz)	DC Resistance (Ω) Max.	Rated Current (mA) Max.	Line To Line Resistance (MΩ) Min.	Rated Voltage (V) Max.	Withstand Voltage (V) Max.
GBDC2012P-900N	90.0 Typ.	100 / 50 mV	0.70	400	100	10.0	25.0
GBDC2012P-101N	100.0 Typ.	100 / 50 mV	0.70	400	100	10.0	25.0
GBDC2012P-121N	120.0 Typ.	100 / 50 mV	0.70	400	100	10.0	25.0

* **Rated Current** : For a 40°C temperature rise from 25°C ambient.

* **Operating Temperature** : - 40°C~125°C

Product Series :	GBDC	Brand :	GOTREND
File Version :	GBDC-SERIES-V1R2	Editor :	Qiuyi Wu
Established Date	2011.08.24	Description :	Multilayer Ferrite Common Mode
Latest Edit Date :	2023.07.12	Product Type :	<input checked="" type="checkbox"/> Standard <input type="checkbox"/> Customize

Care note :

Care note for Use :

(1) Storage Condition :

Temperature 25 to 35 °C , Humidity 45 to 60% RH

(2) Use Temperature :

- a. Minimum Temperature : -25 deg.C (Size : 0605 / 0806) / -40 deg.C (Size : 2012) Ambient temperature of this product.
- b. Maximum Temperature : +85 deg.C (Size : 0605 / 0806) / +125 deg.C (Size : 2012) The value of temperature including ambient and temperature rise of this product.
- c. Reliability test temperature range from -25 ~ +85 deg.C (Size : 0605 / 0806) / -40 ~ +125 deg.C (Size : 2012)
- d. However, this is not meant as temperature grade guarantee for UL.

(3) Model :

When this product was used in a similar or as new product to the original one, sometimes it might be unable to satisfy the specifications due to difference in condition of usage.

(4) Drop :

If this product suffered mechanical stress such as drop, characteristics may become poor (due to damage on coil / bobbin / ferrite ... etc.)

Never use such stressed product.

Care note for Safety :

(1) Provision to Abnormal Condition :

This product itself does not have any protective function in abnormal condition such as overload, short-circuit and open-circuit conditions, etc.

Therefore, it shall be confirmed from the end product that there is no risk of smoking, fire, dielectric withstand voltage insulation resistance, etc. in abnormal conditions to provide protective devices and /or protection circuit in the end product.

(2) Temperature Rise :

Temperature rise on this product depends on the installation condition on end products.

It shall be confirmed on the actual end product that temperature rise of this product is within the specified temperature class limit.

(3) Dielectric Strength :

Dielectric withstanding test with higher voltage than specific value will damage insulating material and shorten its life.

(4) Water :

This product must not be used in wet condition resulted from water, coffee or any liquid contact because insulation strength becomes very low under such condition.

(5) Potting :

If this product is potted in some compound, coating material of magnet wire might be occasionally damaged. Please ask us if you intend to pot this product.

(6) Detergent :

Please consult our company immediately once under such circumstances because product reliability confirmation etc. is needed when this product come in contact with these chemicals.

Product Series :	GBDC	Brand :	GOTREND
File Version :	GBDC-SERIES-V1R2	Editor :	Qiuyi Wu
Established Date	2011.08.24	Description :	Multilayer Ferrite Common Mode
Latest Edit Date :	2023.07.12	Product Type :	<input checked="" type="checkbox"/> Standard <input type="checkbox"/> Customize

Reliability :

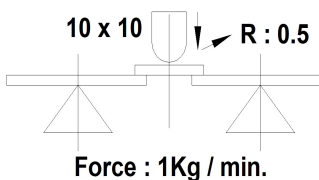
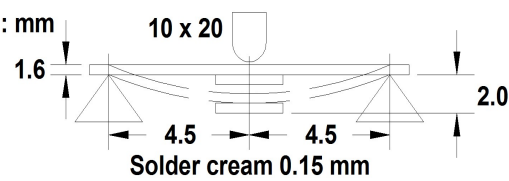
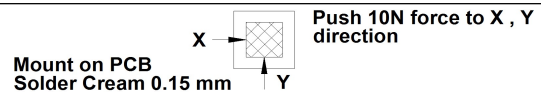
SN	Test Item	Test Condition	Specification		
1	Dimension	Actual Size ...	Meet Spec		
2	Thermal Shock (Temperature Cycle)	Temperature : -25 ~ +85 deg.C (Size : 0605 / 0806) / -40 ~ +125 deg.C (Size : 2012) kept stabilized for 30 min. each Cycle : 100 Cycles (power off)	Elec. no variation Appearance no deformation		
3	Humidity Resistance	Humidity : 90% ~ 95% RH Temperature : 60 ± 2 deg.C, Test Time : 96 ± 2 Hours	Elec. no variation Appearance no deformation		
4	HighTemperature	Temperature : 85 ± 2 deg.C (Size : 0605 / 0806) / 125 ± 2 deg.C (Size : 2012); Testing Time : 96 ± 2 Hours	Elec. no variation Appearance no deformation		
5	Low Temperature	Temperature : -25 ± 2 deg.C (Size : 0605 / 0806) / -40 ± 2 deg.C (Size : 2012); Testing Time : 96 ± 2 Hours	Elec. no variation Appearance no deformation		
6	Temperature and Humidity Cycle	Temperature	Humidity	Time	Elec. no variation Appearance no deformation
		25 deg.C	90% ~ 95% RH	3.0 Hr	
		55 deg.C	95% ~ 96% RH	5.0 Hr	
		25 deg.C	90% ~ 95% RH	3.0 Hr	
		Cycle : 20 Cycles			
7	Vibration	Frequency : 10Hz ~ 55Hz, Amplitude : 1.5 mm Direction : X, Y, Z, Time : 2 Hours each	Elec. no variation Appearance no deformation		
8	Solderability	Go through real SMT IR-Reflow The profile like our suggest profile. Preheat : 160 ± 10 deg.C (90 sec) Peak : 245 ± 5 deg.C Peak Time : 50 Sec. / up 217 deg.C	Elec. no variation Appearance no deformation		
9	Soldering Heat Resistance	Preheat : 160 ± 10 deg.C (90 sec) Solder : Sn / Ag / Cu (Pb Free) Solder Temp. : 260 ± 5 deg.C, Time : 3 ± 1 seconds	Elec. no variation Appearance no deformation		
10	Iron Solder Heat Resistance	Solder Temp. : 350 ± 5 deg.C Flux : Rosin, Time : 3 ± 1 seconds	Elec. no variation Appearance no deformation		
11	Bending Strength	Unit : mm  Force : 1Kg / min.	Elec. no variation Appearance no deformation		
12	Flexure Strength	Unit : mm  Solder cream 0.15 mm	Elec. no variation Appearance no deformation		
13	Terminal Strength	 Mount on PCB Solder Cream 0.15 mm Push 10N force to X, Y direction	Elec. no variation Appearance no deformation		
14	High-Voltage	100 V DC between core & winding	Elec. no variation Appearance no deformation		
15	Load life	Temperature : 25 ± 3 deg.C Load : Allowed DC Current, Test Time : 96 ± 2 Hours	Elec. no variation Appearance no deformation		

Product Series : GBDC	Brand : GOTREND
File Version : GBDC-SERIES-V1R2	Editor : Qiuyi Wu
Established Date 2011.08.24	Description : Multilayer Ferrite Common Mode
Latest Edit Date : 2023.07.12	Product Type : <input checked="" type="checkbox"/> Standard <input type="checkbox"/> Customize

Packaging Information :

Tape Dimension (mm)

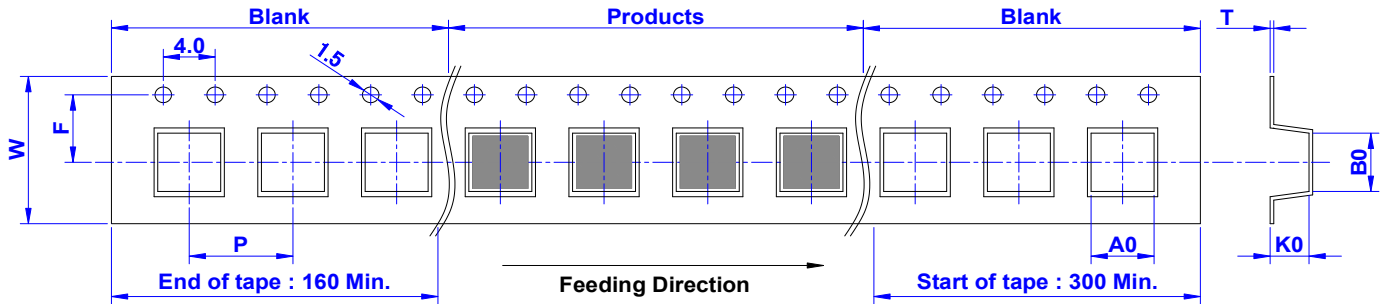

SIZE/mm	A0	B0	W	P	F	K0	T
0605	0.63+/-0.03	0.77 +/-0.03	8.00 +/-0.1	2.00 +/-0.05	3.50 +/-0.05	0.42+/-0.03	0.42 +/-0.03
0806	0.78+/-0.03	1.04+/-0.03	8.00 +/-0.1	2.00 +/-0.05	3.50 +/-0.05	0.60+/-0.03	0.60+/-0.03
2012	1.42 +/-0.1	2.25 +/-0.1	8.00 +/-0.1	4.00 +/-0.1	3.50 +/-0.05	1.22 +/-0.1	0.22 +/-0.05

Reel Dimension (mm)

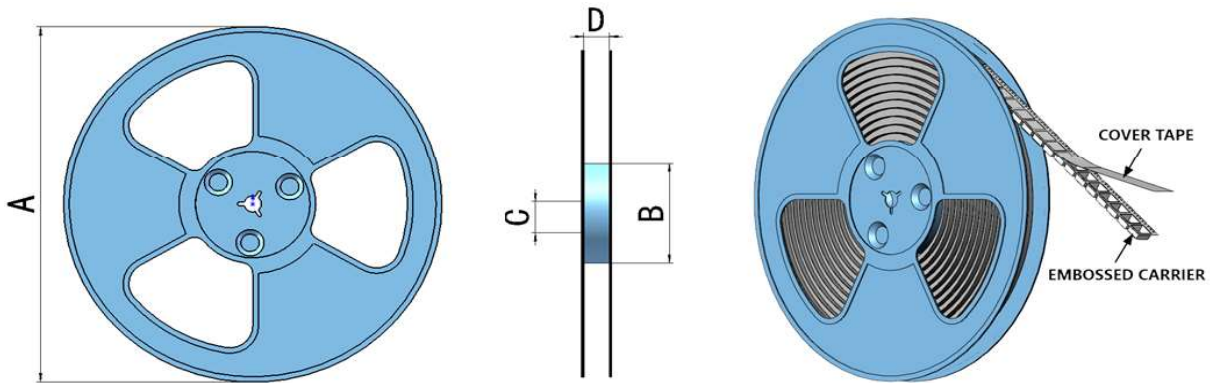

SIZE/mm	Reel Size	A	B	C	D	QTY / Reel
0605	7" x 8 mm	178	60	13	9.0	10000 PCS
0806	7" x 8 mm	178	50	13	10.0	10000 PCS
2012	7" x 8 mm	178	60	13	8.5	4000 PCS

Tearing Off Force

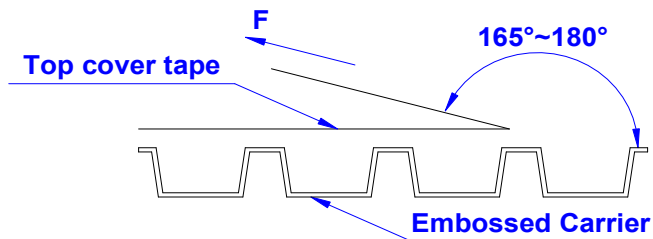

The force for tearing off cover tape is 10 to 130 grams in the arrow direction under the following conditions (referenced ANSI / EIA - 481 - D - 2008 of 4.11 standard).

Room Temp. (°C)	Room Humidity (%)	Room Atm. (hPa)	Tearing Speed (mm / min)
5 ~ 35	45 ~ 85	860 ~ 1060	300

Product Series : GBDC
File Version : GBDC-SERIES-V1R2
Established Date 2011.08.24
Latest Edit Date : 2023.07.12

Brand : GOTREND
Editor : Qiuyi Wu
Description : Multilayer Ferrite Common Mode
Product Type : Standard Customize

Packaging Information :

Box Package

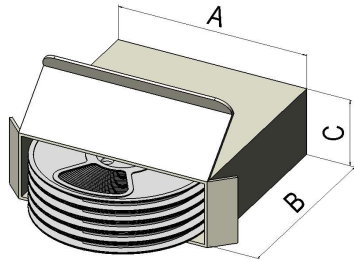

7" Small Box

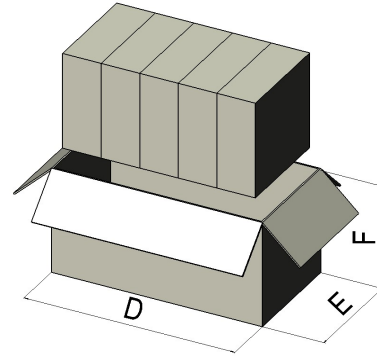

7" Large Box

SIZE/mm	Reels size	A	B	C	Large Box	D	E	F	Reels in Small Box (QTY)	Small Box in Large Box(QTY)
0605	7"	190	195	75	7"	408	210	220	5(50000)	5(250000)
0806	7"	190	195	75	7"	408	210	220	5(50000)	5(250000)
2012	7"	190	195	75	7"	408	210	220	5(20000)	5(100000)